

TTP 4-A

NARROW DIRECTIVITY TWO-WAY SPEAKER

DESCRIPTION

The TTP 4-A point source speaker module delivers top-quality sound for highly demanding events indoors or outdoors on small to medium-sized areas. Its design provides the audio engineer with the best tonal balance and intelligibility with an unobtrusive and adaptable footprint. It is the preferred sound set-up for stacked and flown systems when a controlled dispersion is required. With all the advantages of TT+ technology, such as coherent directivity, power, and precision, it's designed for professional applications.



FEATURES

- 135 dB max SPL
- 60° x 25° coverage
- LF 2 x 10" neodymium woofer, 3.0" voice coil
- HF 1.5" Nd comp. driver 4.0" voice coil
- 2 x Class-D amplifiers, 1600 Watt RMS total power
- 45 - 20.000 Hz frequency range
- RDNet on board
- FiRPHASE 0° linear phase

TECHNICAL SPECIFICATIONS

| | | |
|----------------------------------|----------------------------|---|
| Acoustical specifications | Frequency Response: | 45 Hz ÷ 20000 Hz |
| | Max SPL @ 1m: | 135 dB |
| | Horizontal coverage angle: | 60° |
| | Vertical coverage angle: | 25° |
| Transducers | Compression Driver: | 1 x 1.5" neo, 4.0" v.c |
| | Woofers: | 2 x 10" neo, 3.0" v.c |
| Input/Output section | Input signal: | bal/unbal |
| | Input connectors: | XLR, RDNet Ethercon |
| | Output connectors: | XLR, RDNet Ethercon |
| | Input sensitivity: | +4 dBu |
| Processor section | Crossover Frequencies: | 900Hz |
| | Protections: | Thermal, RMS |
| | Limiter: | Fast Limiter |
| | Controls: | Selectable preset, volume, delay |
| | RDNet: | Yes |
| Power section | Total Power: | 3200 W Peak, 1600 W RMS |
| | High frequencies: | 1200 W Peak, 600 W RMS |
| | Low frequencies: | 2000 W Peak, 1000 W RMS |
| | Cooling: | Convection |
| | Connections: | Powercon IN/OUT |
| Standard compliance | CE marking: | Yes |
| Physical specifications | Cabinet/Case Material: | Baltic birch plywood |
| | Hardware: | Array fittings, 2xM10 on the top, 2xM8 on each side |
| | Handles: | 2 Side, 2 Rear |
| | Pole mount/Cap: | Yes |
| | Grille: | Steel |
| | Color: | Black |
| Size | Height: | 825 mm / 32.48 inches |
| | Width: | 316 mm / 12.44 inches |
| | Depth: | 369 mm / 14.53 inches |
| | Weight: | 30.4 kg / 67.02 lbs |
| Shipping informations | Package Height: | 410 mm / 16.14 inches |
| | Package Width: | 865 mm / 34.06 inches |
| | Package Depth: | 365 mm / 14.37 inches |
| | Package Weight: | 33.5 kg / 73.85 lbs |



PART NUMBER

- **13000604**

TTP 4-A

EAN 8024530017767

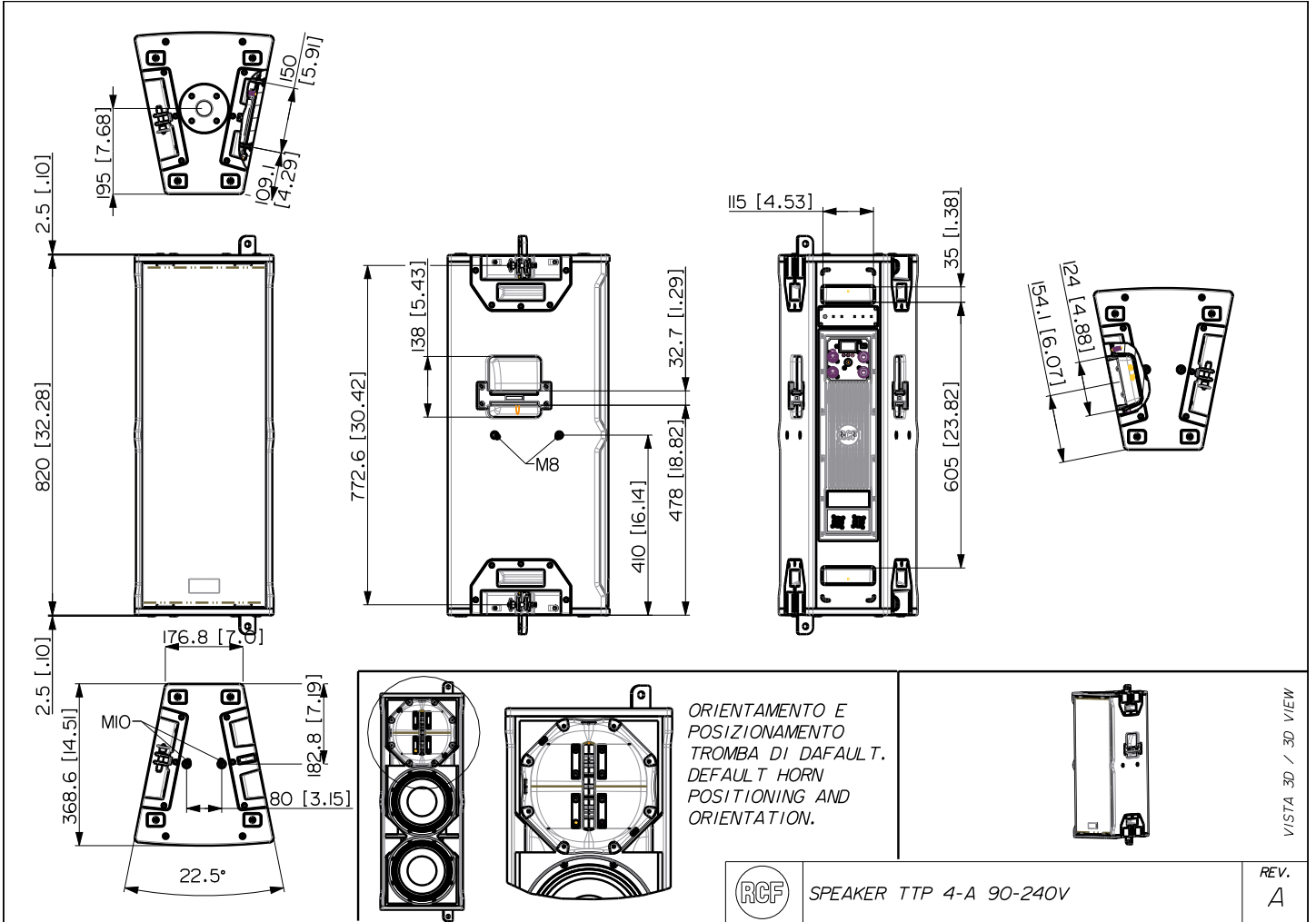

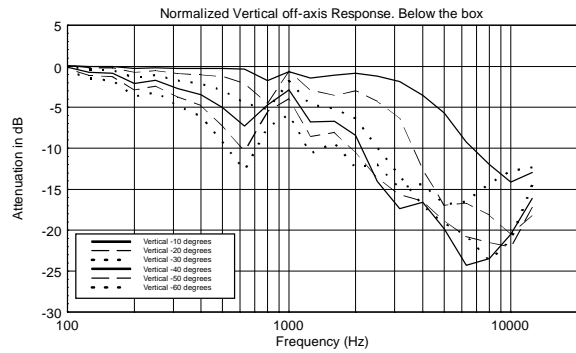
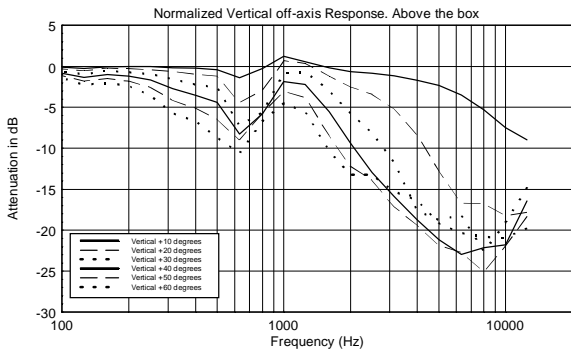
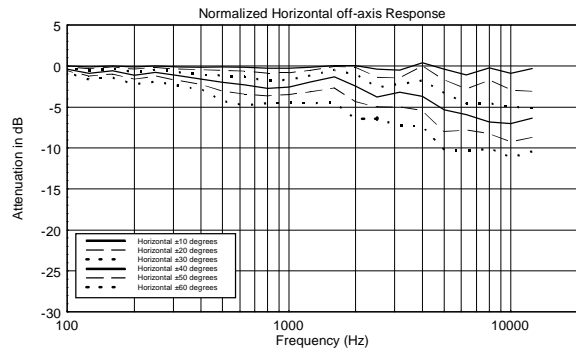
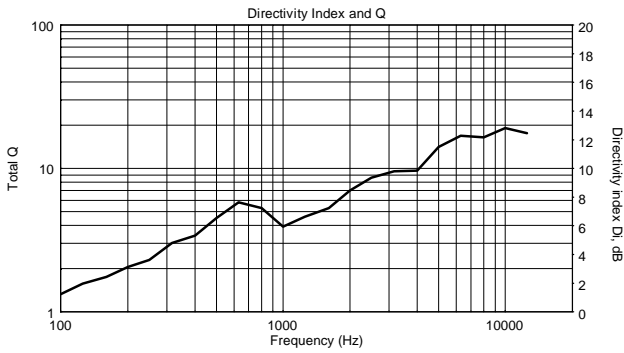
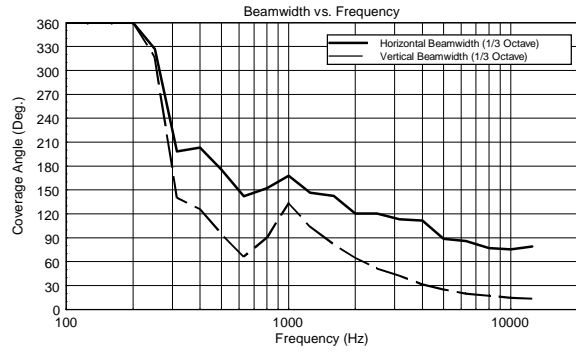
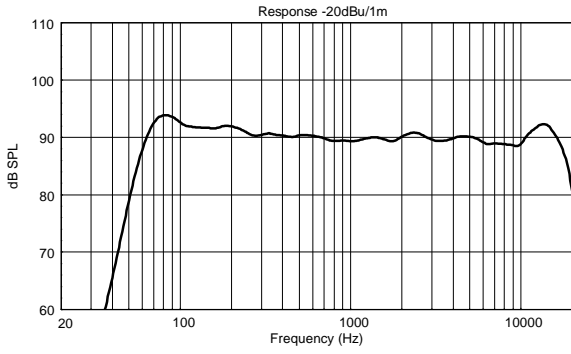

Horizontal 1/3 Octave Polars

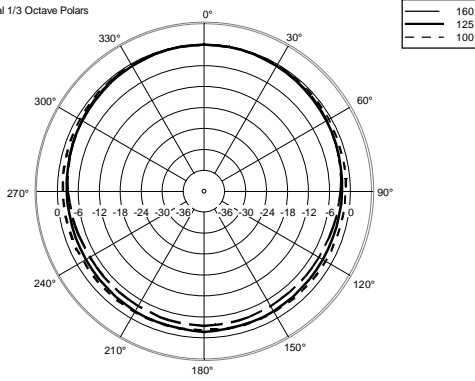

Horizontal 1/3 Octave Polars

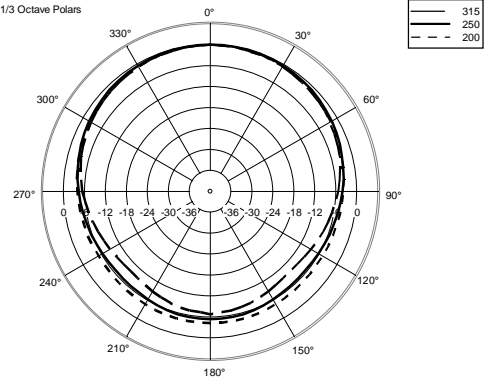

Horizontal 1/3 Octave Polars

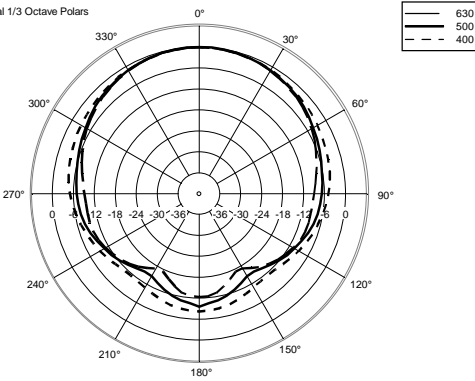

Horizontal 1/3 Octave Polars

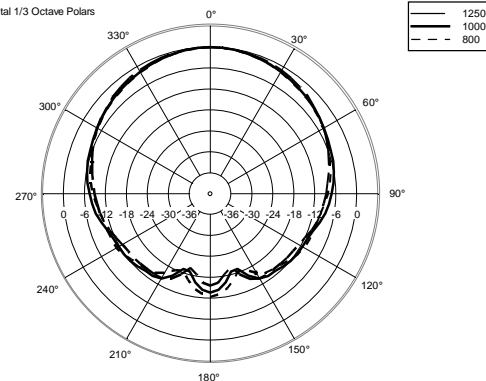

Horizontal 1/3 Octave Polars

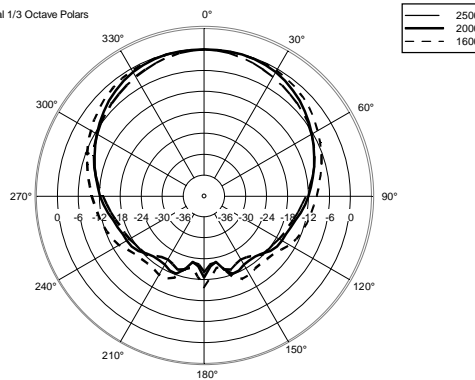

Horizontal 1/3 Octave Polars

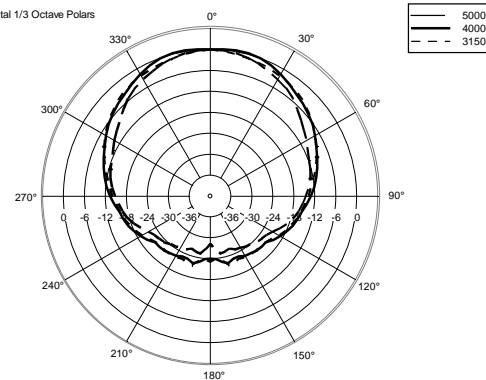

Horizontal 1/3 Octave Polars

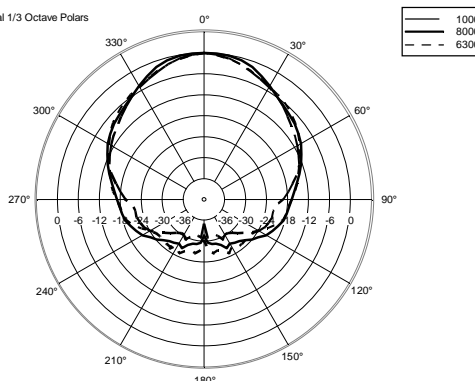



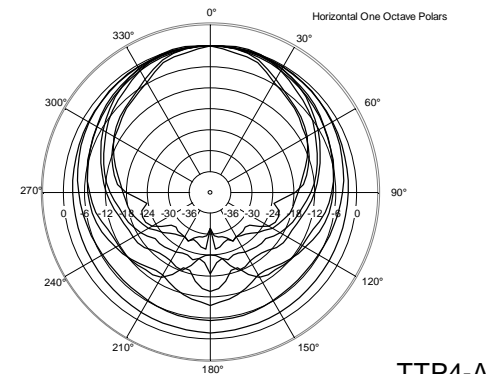

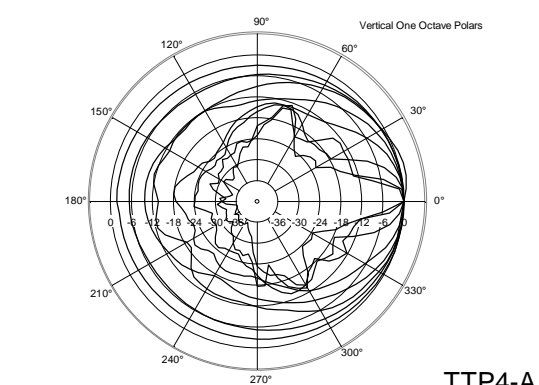
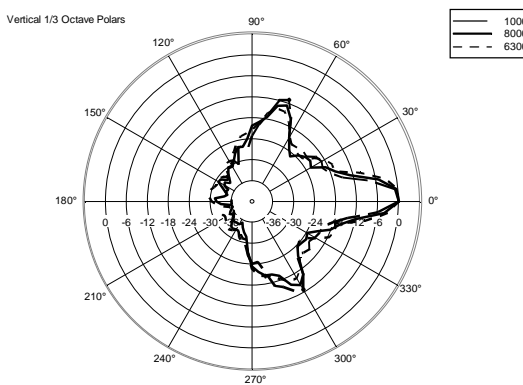
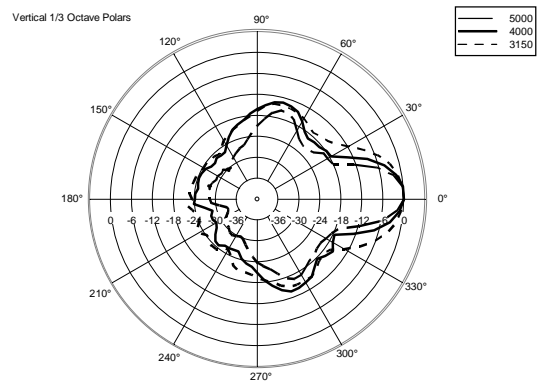
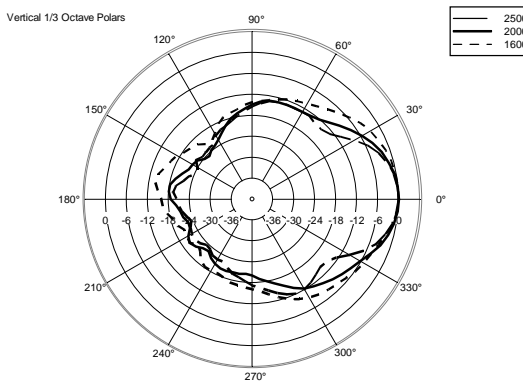
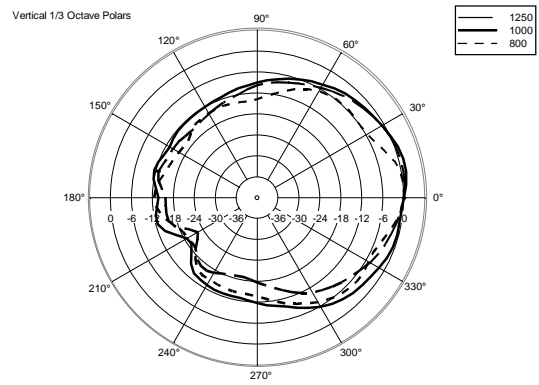
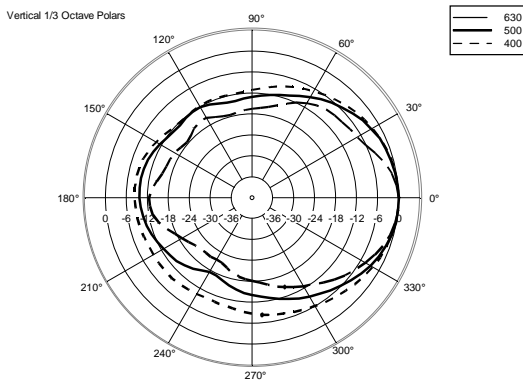
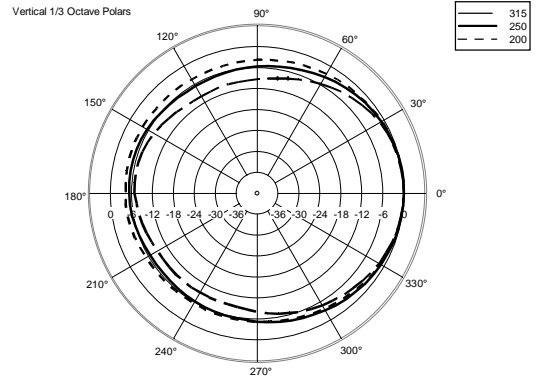
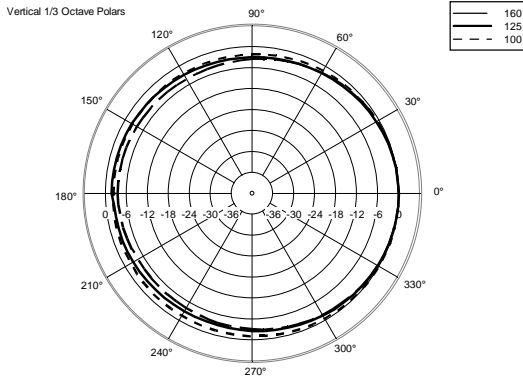



Horizontal One Octave Polars





ACCESSORIES

| | | | |
|---|--|---------------------|----------------------------------|
|  | AC PMA - POLE MOUNT | PART NUMBER EAN: | 13360034 8024530007713 |
|  | AC PMX POLE MOUNT M20 | PART NUMBER EAN: | 13360232 8024530010058 |
|  | AC PRO-FS PROFESS. LOCKING FLOOR STAND | PART NUMBER EAN: | 13360109 8024530006471 |
|  | AC PRO-PM PROFESS. LOCKING POLE MOUNT | PART NUMBER EAN: | 13360110 8024530006488 |
|  | CABLES KIT CBL ETHERCON 0.7M | PART NUMBER EAN: | 12399016 8024530013844 |
|  | CABLES KIT CBL ETHERCON 1.5M | PART NUMBER EAN: | 12399017 8024530013851 |
|  | CABLES KIT CBL ETHERCON 3M | PART NUMBER EAN: | 12399035 8024530013868 |
|  | CABLES KIT CBL ETHERCON 5M | PART NUMBER EAN: | 12399018 8024530013875 |
|  | CABLES KIT CBL ETHERCON TO XLR F 0.2M | PART NUMBER EAN: | 12399019 8024530013882 |



CABLES KIT CBL ETHERCON TO XLR M 0.2M

PART NUMBER **12399020**
EAN: 8024530013899



CABLES KIT CBL POWERCON LINK 0.7M

PART NUMBER **12399031**
EAN: 8024530013738



CABLES KIT CBL POWERCON LINK 1.5M

PART NUMBER **12399030**
EAN: 8024530013721



COVER CVR TT 4

PART NUMBER **13360440**
EAN: 8024530017583



FLY BAR FL-B H TT 4

PART NUMBER **13360425**
EAN: 8024530018498



FLY BAR FL-B V TT 4

PART NUMBER **13360423**
EAN: 8024530017668



LINK BAR FL-B LINK TT 4

PART NUMBER **13360428**
EAN: 8024530017620

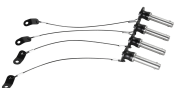

QUICK LOCK PIN QL-PIN D11.2 L31 4X

PART NUMBER **13360335**
EAN: 8024530013257



RAIN PROTECTION RP 1X HDL 30

PART NUMBER **13360388**
EAN: 8024530015138



VERTICAL BRACKET V-BR TT 4

PART NUMBER **13360427**
EAN: 8024530017637

