

# TT 20-CXA

## ACTIVE TWO-WAY HIGH DEFINITION MONITOR

### DESCRIPTION

This active high output stage monitor is a full range, low-profile enclosure with symmetrical transducers arrangement. The optimized frequency and phase response, consistent coverage of 90° x 70°, and potent acoustic output make the TT20-CXA the professional choice for any stage as a monitor or, thanks to the pole socket, as full range front of house system. With an exceptional transient response and the powerful FIRPHASE processing, the TT CXA series far exceeds the capabilities of conventional stage monitors.



### FEATURES

- 131 dB SPL Max
- 1000W RMS, two-way Class-D amplifier
- 90° x 70° constant directivity coverage
- Multifunctional cabinet with symmetrical transducers' design
- FIRPHASE
- 2 x 8" neodymium Woofers, 2.5" voice coil
- Horn loaded 1.4" neo comp. driver, 3" voice coil
- RDNet Networked Management

## TECHNICAL SPECIFICATIONS

|                                  |                            |  |
|----------------------------------|----------------------------|--|
| <b>Acoustical specifications</b> | Frequency Response:        | 60 Hz ÷ 20000 Hz                                 |
|                                  | Max SPL @ 1m:              | 131 dB   |
|                                  | Horizontal coverage angle: | 90°  |
|                                  | Vertical coverage angle:   | 70°  |
| <b>Transducers</b>               | Compression Driver:        | 1 x 1.5" neo, 3.0" v.c                           |
|                                  | Woofers:                   | 2 x 8" neo, 2.5" v.c                             |
| <b>Input/Output section</b>      | Input signal:              | bal/unbal  |
|                                  | Input connectors:          | XLR, RDNet Ethercon                              |
|                                  | Output connectors:         | XLR, RDNet Ethercon                              |
|                                  | Input sensitivity:         | -2 dBu/+4 dBu                                    |
| <b>Processor section</b>         | Crossover Frequencies:     | 900 Hz   |
|                                  | Protections:               | Thermal, HF                                      |
|                                  | Limiter:                   | Fast Limiter                                     |
|                                  | Controls:                  | Bypass, Linear/High Pass, Volume, RDnet on board |
|                                  | RDNet:                     | Yes  |
| <b>Power section</b>             | Total Power:               | 2000 W Peak, 1000 W RMS                          |
|                                  | High frequencies:          | 600 W Peak, 300 W RMS                            |
|                                  | Low frequencies:           | 1400 W Peak, 700 W RMS                           |
|                                  | Cooling:                   | Convection                                       |
|                                  | Connections:               | Powercon IN/OUT                                  |
| <b>Standard compliance</b>       | CE marking:                | Yes  |
| <b>Physical specifications</b>   | Cabinet/Case Material:     | Baltic birch plywood                             |
|                                  | Handles:                   | 1 TOP  |
|                                  | Grille:                    | Steel  |
|                                  | Color:                     | Black  |
| <b>Size</b>                      | Height:                    | 318 mm / 12.52 inches                            |
|                                  | Width:                     | 445 mm / 17.52 inches                            |
|                                  | Depth:                     | 450 mm / 17.72 inches                            |
|                                  | Weight:                    | 14 kg / 30.86 lbs                                |
| <b>Shipping informations</b>     | Package Height:            | 500 mm / 19.69 inches                            |
|                                  | Package Width:             | 490 mm / 19.29 inches                            |
|                                  | Package Depth:             | 375 mm / 14.76 inches                            |
|                                  | Package Weight:            | 16.4 kg / 36.16 lbs                              |



**PART NUMBER**

- **13000560**

TT 20-CXA

115V

EAN 8024530017101

- **13000544**

TT 20-CXA

220-240V

EAN 8024530016807

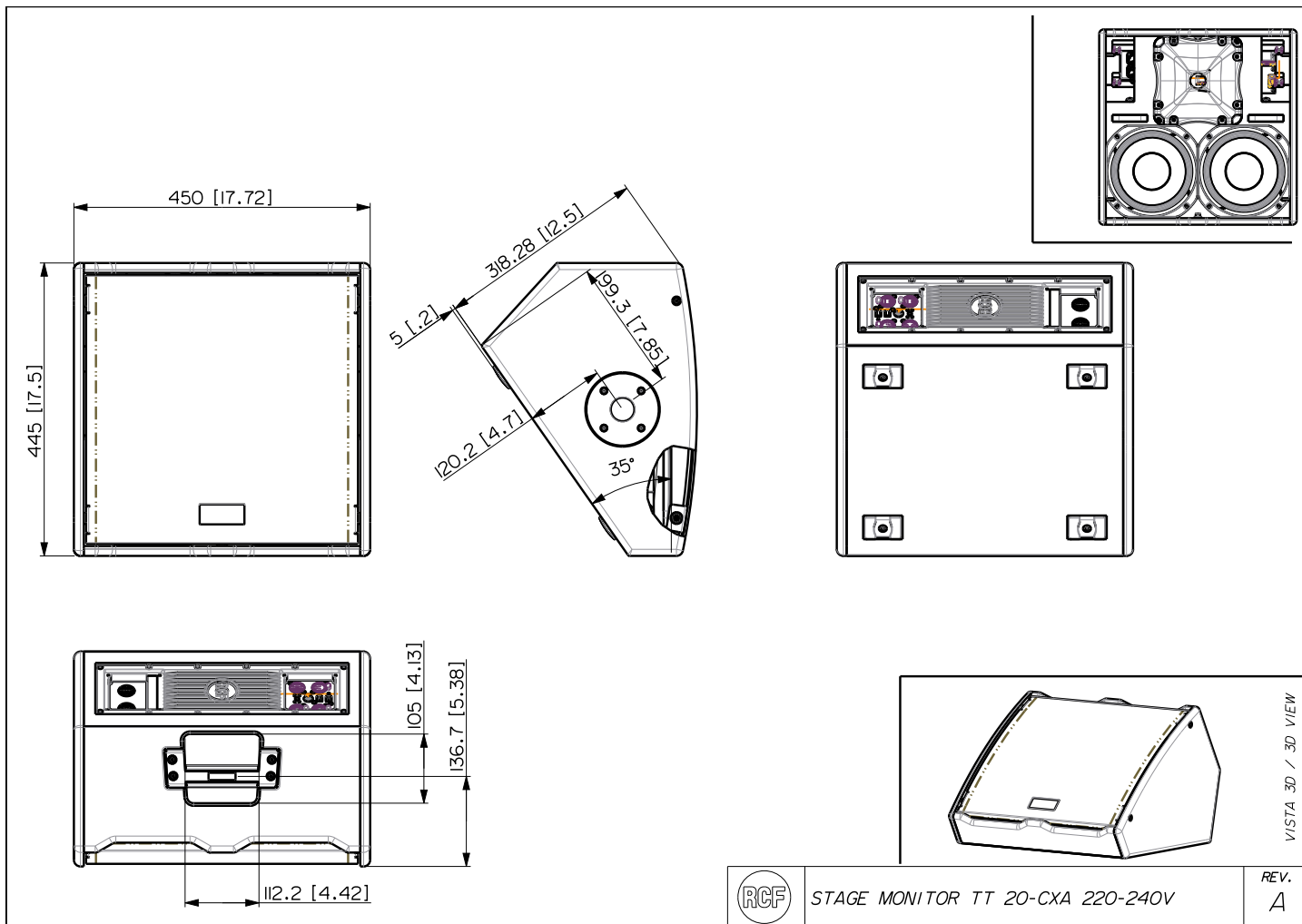

STAGE MONITOR TT 20-CXA 220-240V

REV.  
A

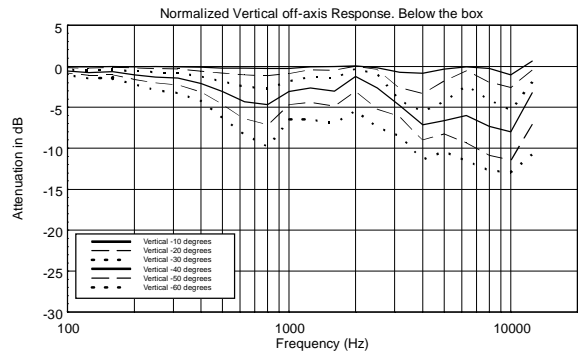
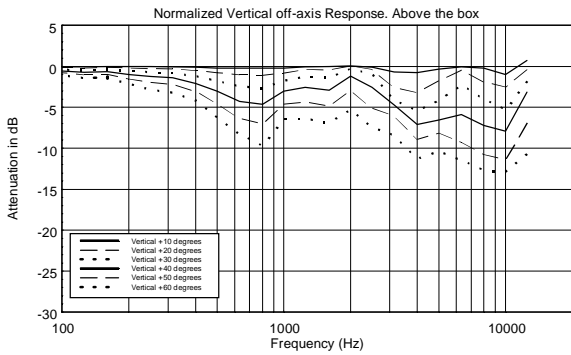
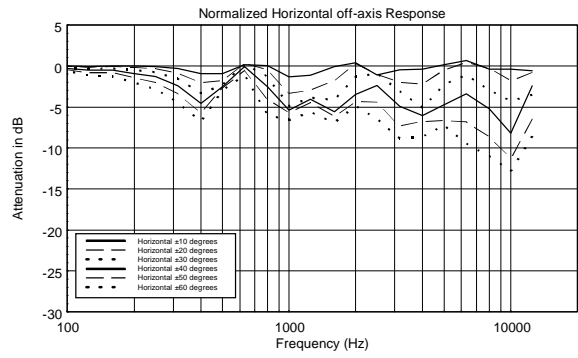
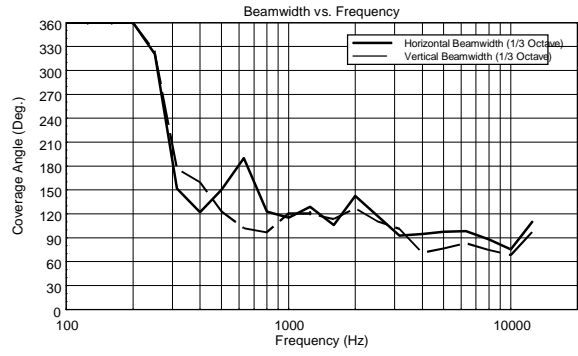
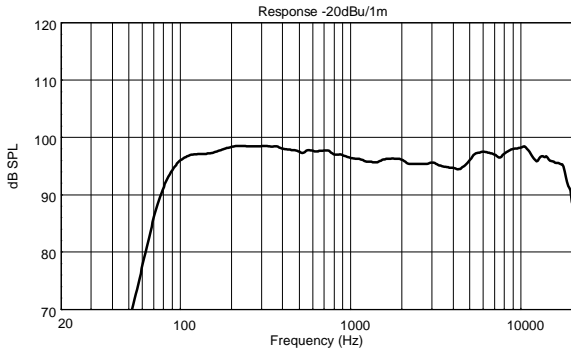

Horizontal 1/3 Octave Polars

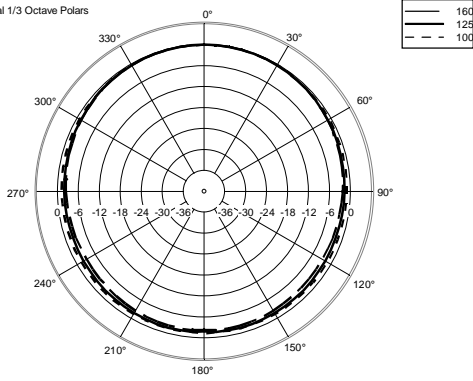

Horizontal 1/3 Octave Polars

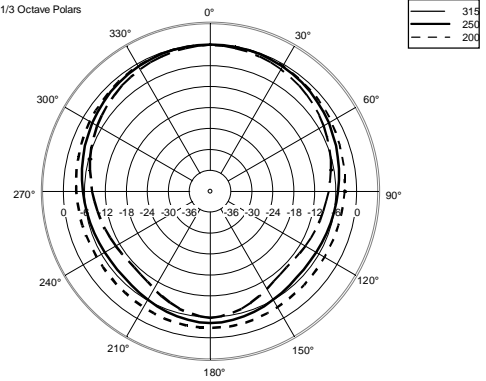

Horizontal 1/3 Octave Polars

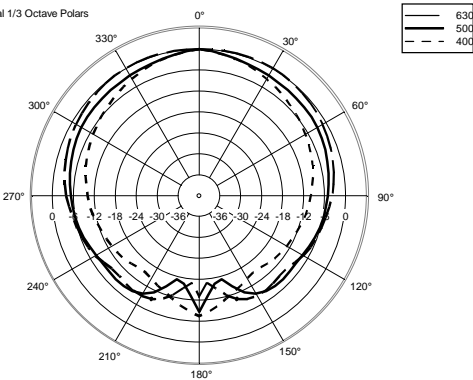

Horizontal 1/3 Octave Polars

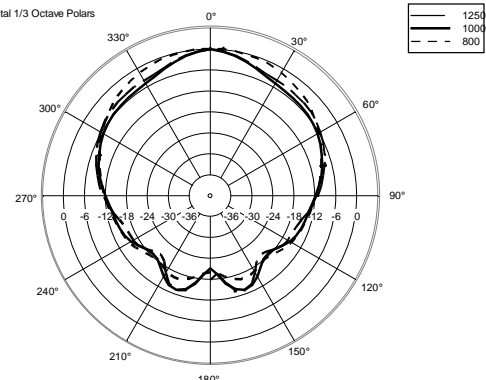

Horizontal 1/3 Octave Polars

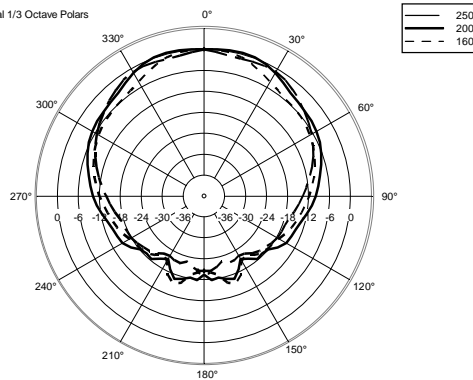

Horizontal 1/3 Octave Polars

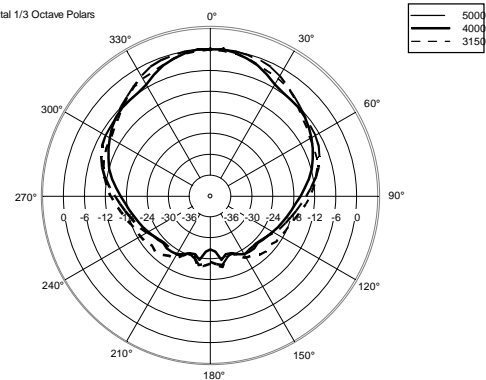

Horizontal 1/3 Octave Polars

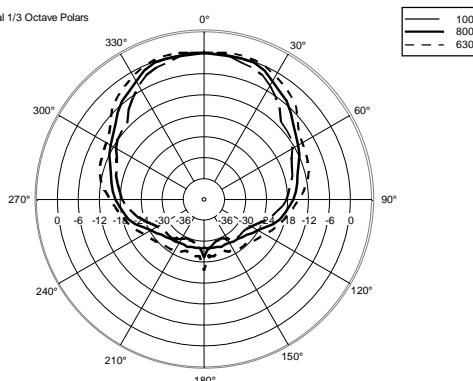

Horizontal One Octave Polars

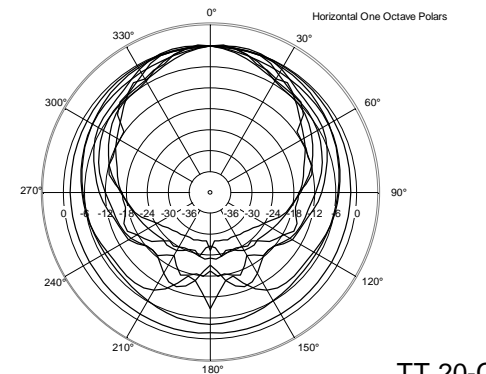

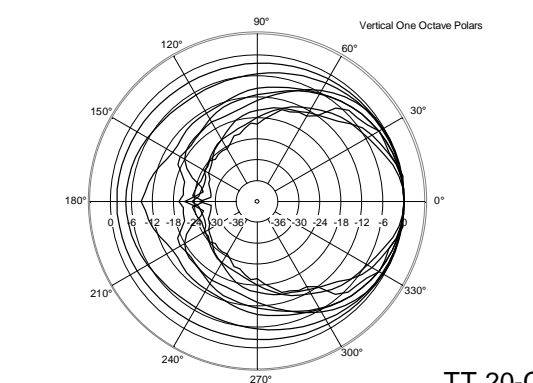
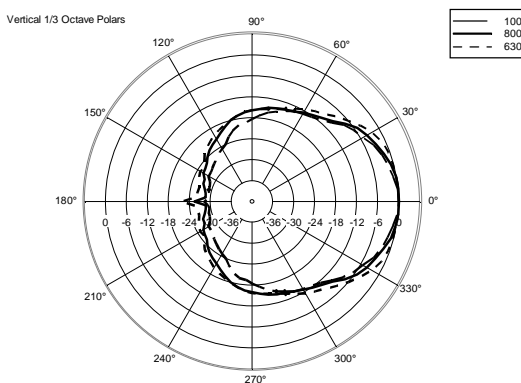
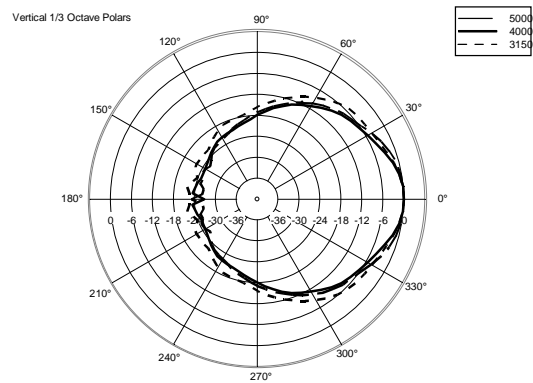
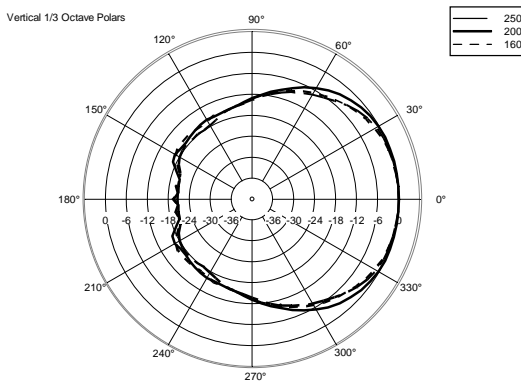
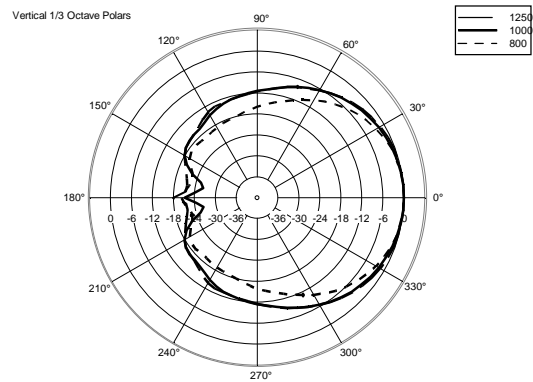
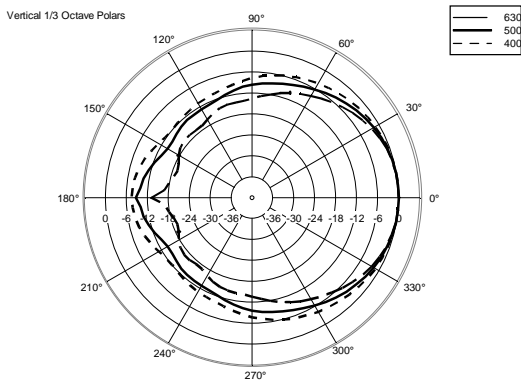
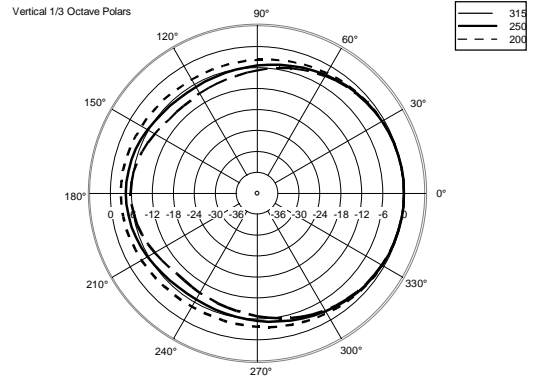
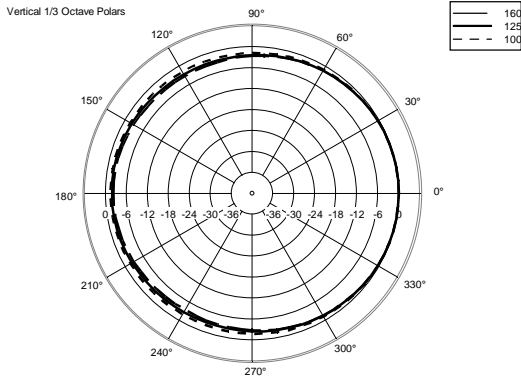

**ACCESSORIES**

AC PMA - POLE MOUNT

PART NUMBER **13360034**  
EAN: 8024530007713

AC PM-M20

PART NUMBER **13360067**  
EAN: 8024530014599

AC PMX POLE MOUNT M20

PART NUMBER **13360232**  
EAN: 8024530010058

AC PRO-FS PROFESS. LOCKING FLOOR STAND

PART NUMBER **13360109**  
EAN: 8024530006471

AC PRO-PM PROFESS. LOCKING POLE MOUNT

PART NUMBER **13360110**  
EAN: 8024530006488

COVER CVR TT 20-CXA

PART NUMBER **13360405**  
EAN: 8024530016340

RAIN PROTECTION RP 1X HDL 6

PART NUMBER **13360381**  
EAN: 8024530015169