

HF64

PRO HF HORN

DESCRIPTION

1-inch/1.4 inch Throat Adaptor. 60° x 40° Constant Directivity Coverage. Thick Aluminum Body for best heat dissipation in conjunction to Neodimium Compression Drivers.



FEATURES

- 1-inch/1.4 inch Throat Adaptor
- 60° x 40° Constant Directivity Coverage
- Loading down to 500 Hz
- Thick Aluminum Body for best heat dissipation in conjunction to Neodimium Compression Drivers
- Perfectly Controlled Dispersion

TECHNICAL SPECIFICATIONS**General specifications**

Throat Diameter:	25-36 mm / 1.0-1.4 inch
Horizontal coverage angle:	60°
Vertical coverage angle:	40°
Cut-off Frequency:	500 Hz
Material:	Aluminium

Mounting informations

Overall height:	250 mm / 9.84 inches
Overall width:	25 mm / 0.98 inches
Overall depth:	179 mm / 7.05 inches
Baffle Cut-out height:	205 mm / 8.07 inches
Baffle Cut-out width:	205 mm / 8.07 inches
Mounting:	4 x 7 mm holes, interaxes 101 mm/76 mm

Standard compliance

CE marking:	Yes
-------------	-----

Size

Height:	186 mm / 7.32 inches
Diameter:	250 mm / 9.84 inches
Weight:	1.48 kg / 3.26 lbs

Shipping informations

Package Height:	195 mm / 7.68 inches
Package Width:	265 mm / 10.43 inches
Package Depth:	260 mm / 10.24 inches
Package Weight:	2.4 kg / 5.29 lbs

PART NUMBER

- **13133046**

HF64

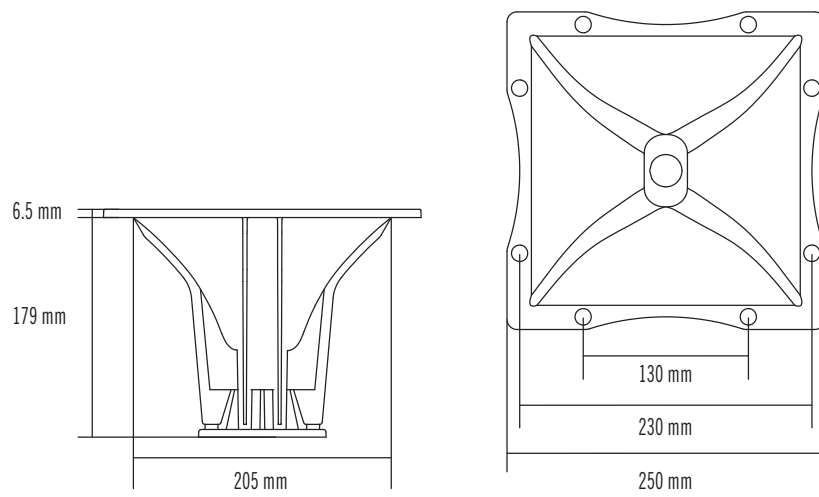

Response 1W/1m

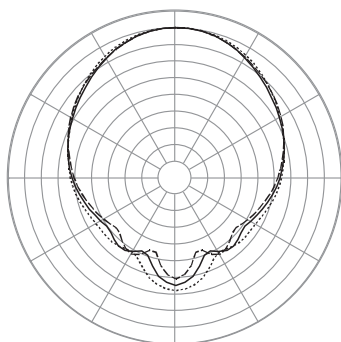
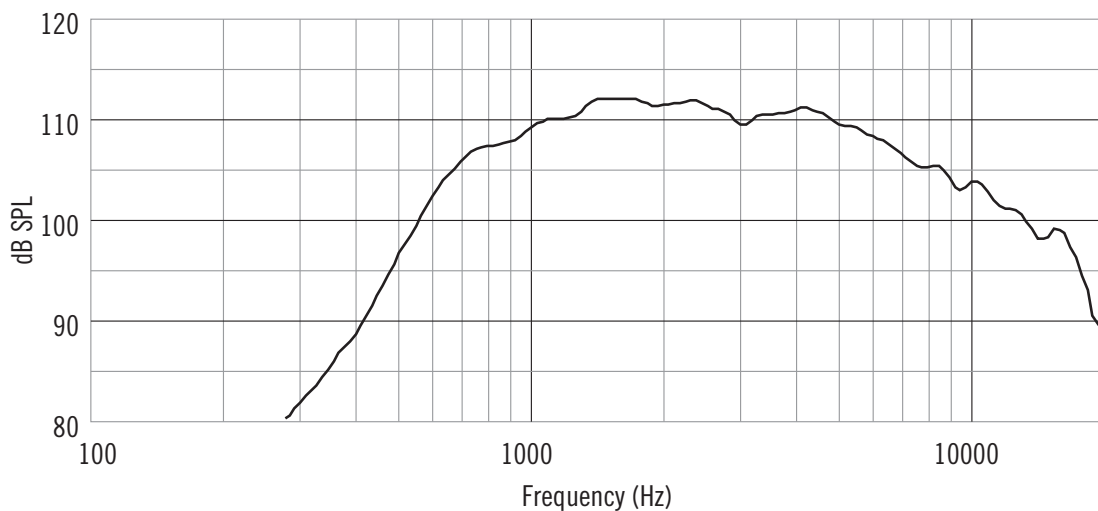

Horizontal 2000 Hz
1/3 Octave Polars

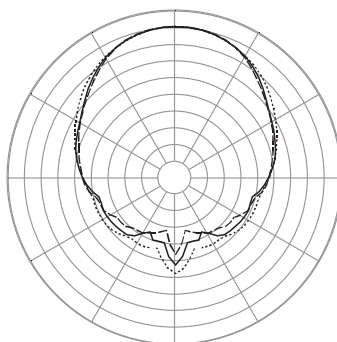

Horizontal 4000 Hz
1/3 Octave Polars

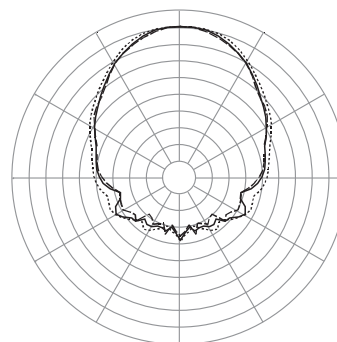

Horizontal 8000 Hz
1/3 Octave Polars

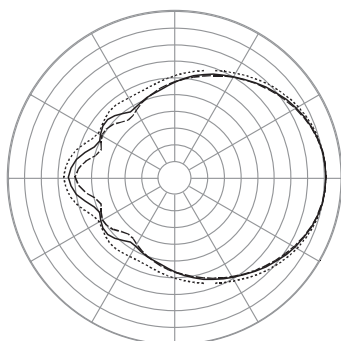

Vertical 2000 Hz
1/3 Octave Polars

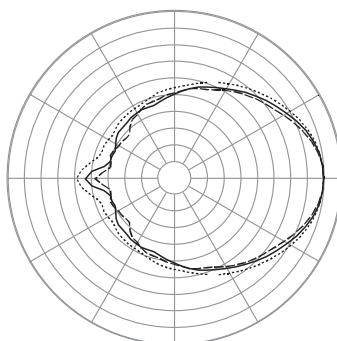

Vertical 4000 Hz
1/3 Octave Polars

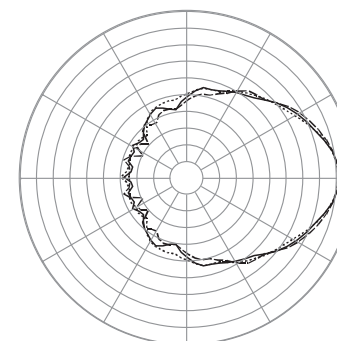

Vertical 8000 Hz
1/3 Octave Polars