



Technische Informationen

Engineering Data Sheet

Sub 1.15

1 x 15"
Subwoofer

Features:

- Power Handling Rated 500 W / 8 Ohms Peak 2000 W
- 15" EVS-15S LF Transducer
- Integrated Low Pass Filter
- 94 dB Sensitivity, 127 dB Maximum SPL
- Pole Mount to elevate a Loudspeaker

	Sub 1.15
Order No.	F01U165094
Cabinet	Subwoofer
Configuration	Vented-Direct Radiator
Nominal Impedance	8 Ohms
Minimum Impedance	6.9 Ohms
Rated Power RMS	500 W
Peak Power	2000 W
Sound pressure level	
SPL 1 W / 1 m	94 dB
Max. SPL 1 m (calculated with peak power)	127 dB
Frequency Range (-10 dB)	40 Hz to 260 Hz
Nominal Coverage Angle (Horizontal x Vertical)	Omnidirectional
LF Transducer	EVS-15S, 15" (381 mm) driver
Connectors	2x Neutrik Speakon NL4 Sub 1+ / 1- Wired through 2+ / 2-
Dimensions (W x H x D)	445 mm x 605 mm x 550 mm (17.5" x 23.8" x 21.7")
Net Weight	28.5 kg (62.8 lbs)
Shipping Weight	31.4 kg (69.2 lbs)
Enclosure material	MDF with D-PUR PLUS
Grille	Steel, Black Finish with Acoustic Gauze
Warranty	5 years
Spare Parts	
LF Transducer	F01U106974



Wir weisen ausdrücklich darauf hin, dass bei gehängten Lautsprecherboxen die einschlägigen Sicherheitsbestimmungen zu beachten sind. Es muss unbedingt qualifizierte Fachberatung in Anspruch genommen werden!

We expressly point out that the relevant safety regulations must be observed for "flying" loudspeaker systems. It is imperative that qualified expert advice is sought.

WARNING:

**THIS LOUDSPEAKER SYSTEM CAN PERMANENTLY DAMAGE HEARING!
USE EXTREME CARE WHEN SETTING SOUND PRESSURE LEVELS!**

DANGER:

CONSULT A CERTIFIED STRUCTURAL ENGINEER BEFORE ANY ATTEMPT TO SUSPEND THIS LOUDSPEAKER! LOUDSPEAKER CAN FALL FROM IMPROPER SUSPENSION, RESULTING IN SEVERE INJURY AND DAMAGE OF PROPERTY. DO NOT SUSPEND OR MOUNT ANY OTHER PRODUCT OR DEVICE FROM THIS LOUDSPEAKER ENCLOSURE! USE GRADE 5 HARDWARE OR BETTER ONLY!

Beschreibung

Der Subwoofer Sub 1.15 (1 x 15" EVS-15S woofer) ist die ideale kompakte Bass-Erweiterung für die Corus C 12.2 Fullrange-Box. Aufgrund des eingebauten Tiefpass-Filters kann sie bei Bedarf einfach im Single-Amp-Betrieb parallel betrieben werden. Empfehlenswert ist darüber hinaus natürlich die Kombination mit den Controllern DSP 260 oder DSP 600 und Endstufen der SL-Serie oder LX-Serie zum Aufbau aktiver Zweiweg-Systeme.

Description

The subwoofer Sub 1.15 (1 x 15" EVS-15S woofer) is the ideal compact bass extension for the Corus C 12.2 full-range cabinet. Thanks to the integrated low-pass filter, it can, if desired, be operated simply in parallel in Single Amp mode. Also recommended, naturally, is the combination with the controllers DSP 260 or DSP 600 and power amplifiers from the SL or LX series for the creation of active two-way systems.

Illustration 1: Dimensions

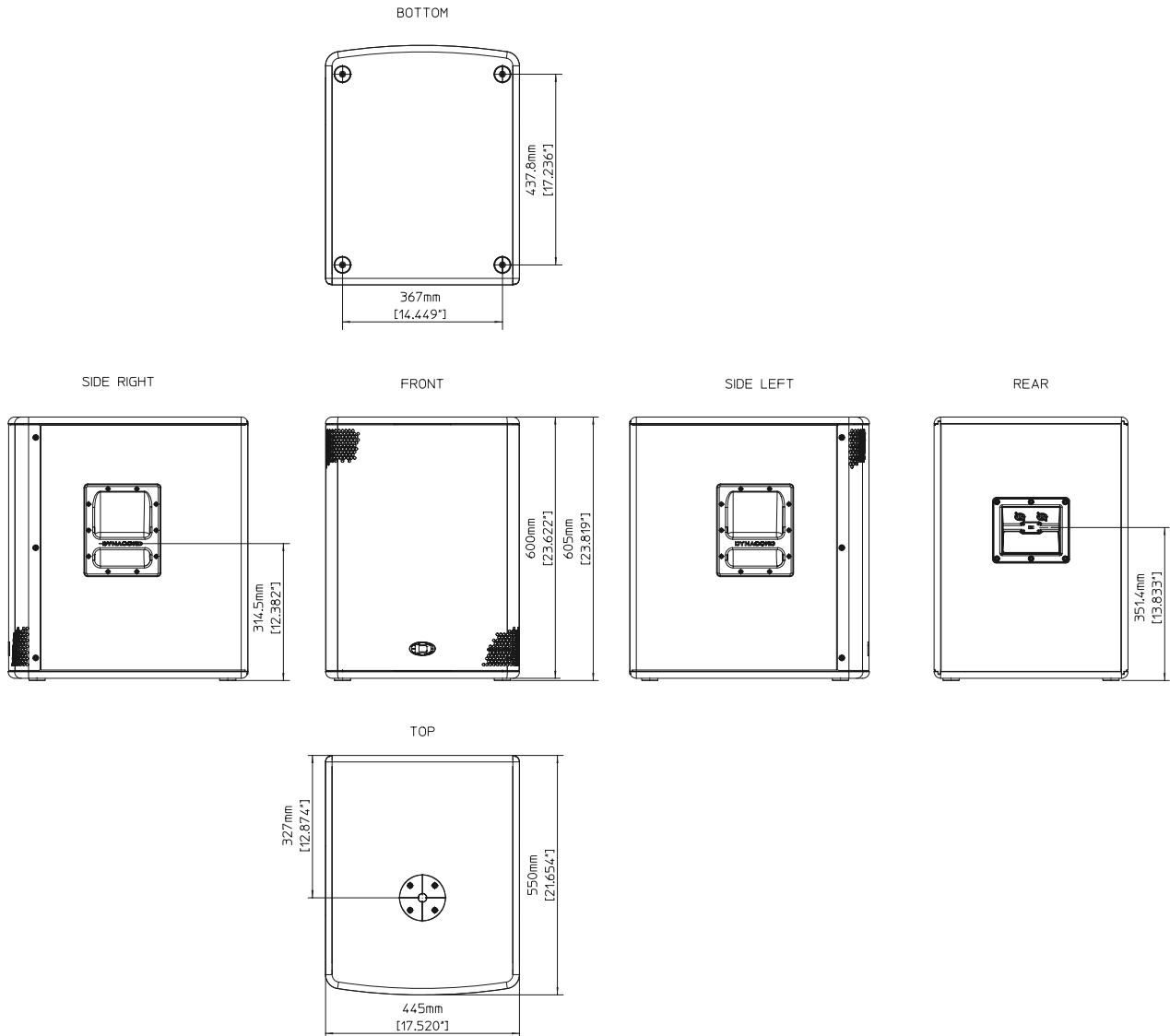

Illustration 2: Frequency Response

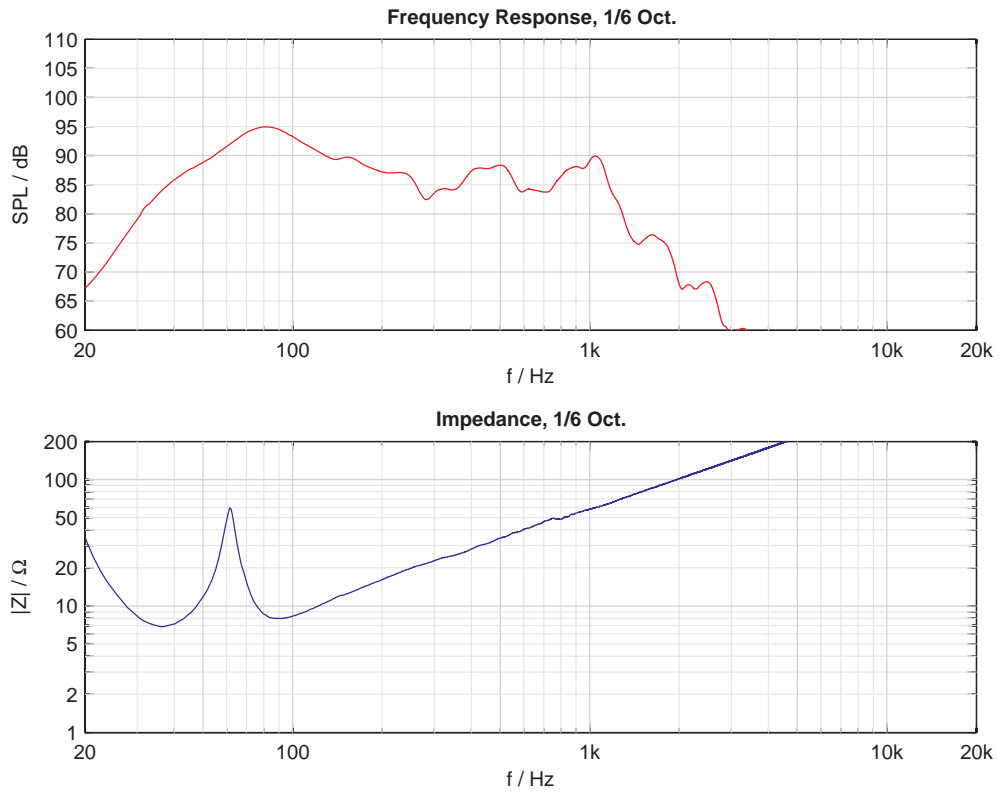
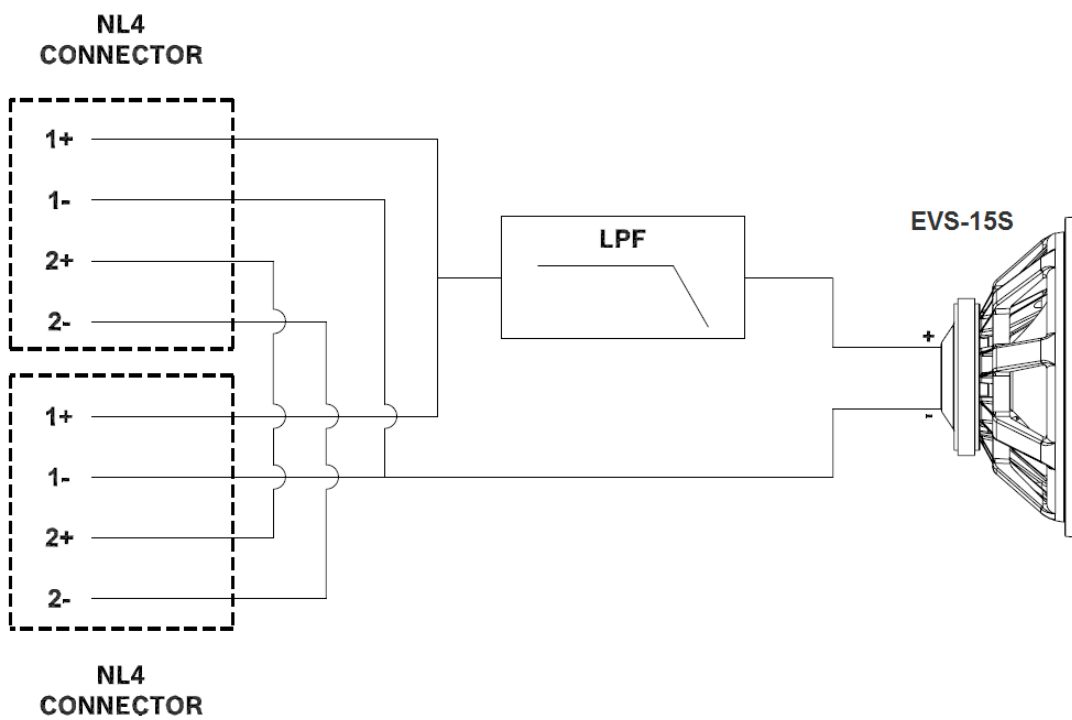

Illustration 3: Block diagram





12000 Portland Avenue South, Burnsville, MN 55337, USA
Phone: +1 952/844-4051, Fax: +1 952/884-0043

www.dynacord.com

© Bosch Communications Systems 11/2010
Part Number F01U165447 Vs 02

Europe, Africa, and Middle East only. For customer orders, contact Customer Service at:
+49 9421-706 0 Fax: +49 9421-706 265

Asia & Pacific only. For customer orders, contact Customer Service at:
+65 6571 2534 Fax: +65 6571 2699

For technical assistance, contact Technical Support at: **+49 9421-706 0**

Specifications subject to change without notice.