

ADORN



SIGNATURE SOUND FOR COMMERCIAL
ON-WALL INSTALLATION APPLICATIONS

Unite Your Audience
The Martin Audio Experience



ADORN

Martin Audio ADORN on-wall loudspeakers bring class-leading performance, reliability and value to a wide range of commercial sound installations — from retail outlets, bars and restaurants to corporate offices. From the café to the boardroom, ADORN loudspeakers are designed for distributed sound applications that require high performance from visually-discreet, ultra-compact enclosures.

With Martin Audio signature sound characteristics, the two-way A40 and A55 are the perfect choice for back-ground and foreground systems which require superior sound quality. They also provide a seamless sonic transition within a multi-zoned complex using larger Martin Audio systems such as CDD or BlacklineX.



FEATURES

- Contemporary, unobtrusive design
- High output capability
- High fidelity sound
- Low and high-frequency overload protection
- 70V/100V transformer options
- Vertical or horizontal orientation
- Wide 110° x 80° coverage
- Wall bracket included
- 5-year warranty

APPLICATIONS

- Retail outlets
- Cafes, bars and restaurant chains
- Hotels and convention centres
- Educational facilities
- Corporate offices

AESTHETIC ENCLOSURES

ADORN full-range enclosures are visually unobtrusive with smooth lines. Available in black or white as standard, they can be readily painted to match any interior décor and architectural environment.

LOW IMPEDANCE AND TRANSFORMER OPTIONS

The A40 and A55 have a nominal impedance of 16 ohms, enabling four or more speakers to be driven in parallel by one amplifier channel, thereby maximising efficiency and minimising cost. Their 'T'- designated options are fitted with an internal high-quality 70V/100V multi-tap line transformer with a switch to select the output level.

OVERLOAD PROTECTION

For full-bandwidth protection, the low and high-frequency sections are individually protected against overload in both low-impedance and transformer models.





A40/A40T

The A40 is a two-way passive speaker with an elegant design that is perfect for architectural interiors that require high-fidelity sound from an unobtrusive, ultra-compact enclosure. Comprising a 4" (100mm) LF driver and a 0.75" (19mm) silk-dome HF driver on a 110° x 80° horn, it handles 40W AES, 160W peak and can produce 109dB peak output at 1 metre.

Its paintable ABS enclosure can be wall-mounted vertically or horizontally using the mounting bracket supplied. With a nominal impedance of 16 ohms, multiple speakers can be driven in parallel from a single channel of a low impedance amplifier such as the Martin Audio VIA2004. The A40T transformer option features a built-in 70V/100V multi-tap transformer for line operation.



A55/A55T

The A55 features a 5.25" (135mm) LF driver and a 0.75" (19mm) silk-dome HF driver on a 110° x 80° horn. With a power handling of 50W AES, 200W peak, and a maximum SPL of 113dB at 1 metre, it is designed for background and foreground applications that call for premium sound quality and high levels from a visually-discreet enclosure.

It can be wall-mounted vertically or horizontally using the mounting bracket supplied and its nominal impedance of 16 ohms enables multiple speakers to be driven in parallel from a single channel of a low impedance amplifier such as the Martin Audio VIA2004. A transformer option, the A55T, with a built-in 70V/100V multi-tap transformer is available for line operation.

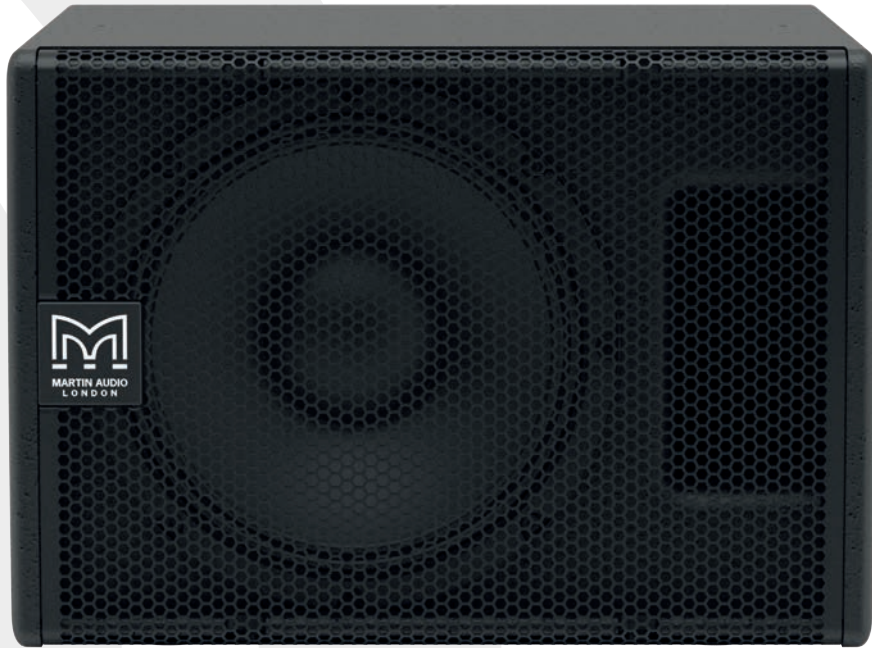

SX110 SUBWOOFER

The SX110 subwoofer will extend the bandwidth of ADORN on-wall speakers and is ideal for foreground music applications which require increased impact and low frequency performance.

Designed to be able to sit under banquette seating or discreetly placed within a venue, its ultra-compact enclosure features a 10" (250mm) driver and generous bass-reflex porting to reduce air noise. The SX110 can also be suspended by means of integral M8 threaded inserts.



RECOMMENDED AMPLIFIER AND CONTROLLER

The A40 and A55 recommend amplifier is the Martin Audio VIA2004. This four channel high performance, cost effective power amplifier can also partner with the DX0.5 controller for small scale efficient installations, or with the DX4.0 controller for larger more complex installations, which could then also be managed by Martin Audio's VU-NET control software platform. For the A40T and A55T the recommended amplifier is the VIA5002 in conjunction with a suitable line transformer.



TECHNICAL SPECIFICATIONS

A40

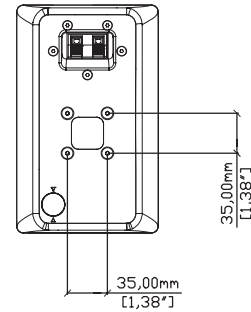
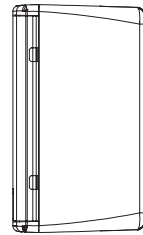
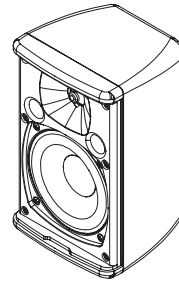
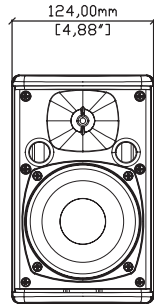
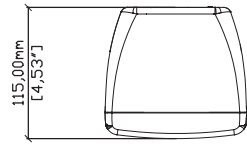
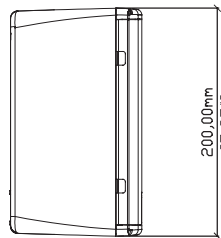

A55

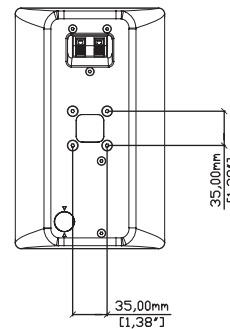
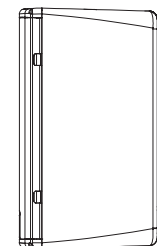
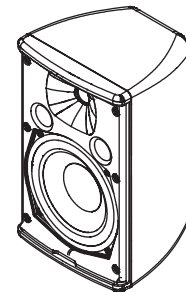
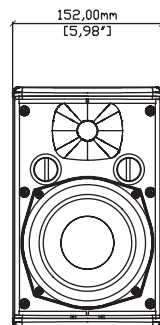
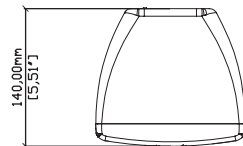
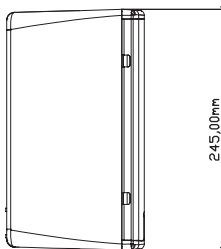

A40/A40T

TYPE	Ultra-compact passive two-way system, front ported bass reflex
FREQUENCY RESPONSE (1)	98Hz-17kHz \pm 3dB -10dB @ 70Hz
DRIVERS	LF: 4" / 1" high-temp voice coil, coated paper cone, rubber surround, ferrite motor, pressed steel chassis HF: 0.75" silk dome, neodymium motor
RATED POWER (2)	40W AES, 160W peak
RECOMMENDED AMPLIFIER	A40: VIA2004 A40T: VIA5002
SENSITIVITY (1)	87dB/1W/1m
MAXIMUM SPL (9)	109dB peak
NOMINAL IMPEDANCE	16 ohms
DISPERSION (-6dB)	110° H x 80° V
CROSSOVER	3.5kHz passive (LF and HF auto-resetting fuses)
TRANSFORMER TAPS (A40T only)	70V: 20w / 10w / 5w / 2.5w 100V: 20w / 10w / 5w
RECOMMENDED HIGH-PASS FILTER	60Hz 24dB/oct
ENCLOSURE	ABS, UL 94V-0 rated
FINISH	Black or white
GRILLE	Perforated steel
CONNECTORS	Push terminals
FITTINGS	Wall bracket included
DIMENSIONS EXCL. BRACKET	(W) 124mm x (H) 200mm x (D) 114mm (W) 4.9in x (H) 7.9in x (D) 4.5in
WEIGHT	A40: 1.75kg (3.9lbs) A40T: 2.13kg (4.7lbs)
ACCESSORIES	Waterproof connector cover Water resistant grille

Notes

- (1) Measured on-axis in half (2pi) space at 2 metres, then referred to 1 metre.
- (2) AES Standard ANSI S4.26-1984.
- (3) Measured in half (2pi) space at 2 metres with 1 watt input, using band limited pink noise, then referred to 1 metre.
- (4) Measured in half (2pi) space at 2 metres using band limited pink noise, then referred to 1 metre.
- (5) Measured on-axis in open (4pi) space at 2 metres, then referred to 1 metre.
- (6) Measured in open (4pi) space at 2 metres with 1 watt input, using band limited pink noise, then referred to 1 metre.
- (7) Measured in open (4pi) space at 2 metres using band limited pink noise, then referred to 1 metre.
- (8) Measured in open (4pi) space at 2 metres with 2.83v input, using band limited pink noise, then referred to 1 metre.
- (9) Calculated at 1 metre.
- (10) Measured in half (2pi) space at 2 metres with 2.83V input, using band limited pink noise, then referred to 1 metre.

A55/A55T

TYPE	Ultra-compact passive two-way system, front ported bass reflex
FREQUENCY RESPONSE (1)	90Hz-17kHz ± 3dB -10dB @ 65Hz
DRIVERS	LF: 5.25" /1" high-temp voice coil, coated paper cone, rubber surround, ferrite motor, pressed steel chassis HF: 0.75" silk dome, neodymium motor
RATED POWER (2)	50W AES, 200W peak
RECOMMENDED AMPLIFIER	A55: VIA2004 A55T: VIA5002
SENSITIVITY (1)	90dB/1W/1m
MAXIMUM SPL (9)	113dB peak
NOMINAL IMPEDANCE	16 ohms
DISPERSION (-6dB)	110° H x 80° V
CROSSOVER	3.5kHz passive (LF and HF auto-resetting fuses)
TRANSFORMER TAPS (A55T only)	70V: 30w / 15w / 7.5w / 3.75w 100V: 30w / 15w / 7.5w
RECOMMENDED HIGH-PASS FILTER	60Hz 24dB/oct
ENCLOSURE	ABS, UL 94V-0 rated
FINISH	Black or white
GRILLE	Perforated steel
CONNECTORS	Push terminals
FITTINGS	Wall bracket included
DIMENSIONS EXCL. BRACKET	(W) 152mm x (H) 245mm x (D) 140mm (W) 6in x (H) 9.6in x (D) 5.5in
WEIGHT	A55: 2.21kg (4.9lbs) A55T: 2.81kg (6.2lbs)
ACCESSORIES	Waterproof connector cover Water resistant grille

SX110

TYPE	Ultra-compact, direct radiating subwoofer
FREQUENCY RESPONSE (1)	50Hz-150Hz ± 3dB -10dB @ 42Hz
DRIVER	1 x 10" (250mm)/2" (50mm) voice coil, long excursion, ferrite magnet
RATED POWER (2)	250W AES, 1000W peak
RECOMMENDED AMPLIFIER	VIA 2004
SENSITIVITY (10)	97dB
MAXIMUM SPL (9)	121dB continuous, 127dB peak (half space)
NOMINAL IMPEDANCE	8 ohms
DISPERSION (-6dB)	Omnidirectional
CROSSOVER	80-120Hz active
ENCLOSURE	Plywood
FINISH	Black or white
PROTECTIVE GRILLE	Perforated steel
CONNECTORS	2 x NL4 type
PIN CONNECTIONS (INPUT)	+1, -1 Link through: +2, -2
PIN CONNECTIONS (LINK)	+1, -1 Link through: +2, -2
FITTINGS	12 x M8 inserts
DIMENSIONS (INCL FEET)	(W) 417mm x (H) 297mm x (D) 415mm (W) 16.4ins x (H) 11.7ins x (D) 16.3ins
WEIGHT	12kg (26.5lbs)

SX110

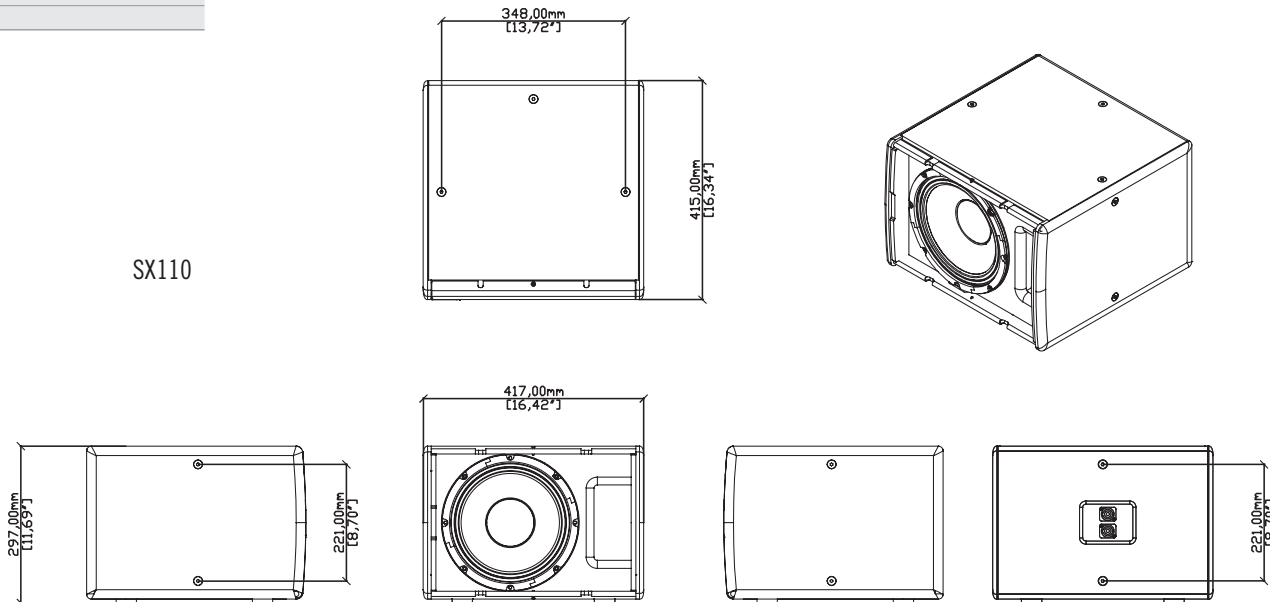

ADORN

SIGNATURE SOUND FOR COMMERCIAL
ON-WALL INSTALLATION APPLICATIONS

Martin Audio Limited

Century Point

Halifax Road

Cressex Business Park

High Wycombe

Buckinghamshire

HP12 3SL

England

FOR SALES ENQUIRIES:

UK

Telephone: +44 (0)1494 535312

E-mail: info@martin-audio.com

NORTH AMERICA

Telephone: 818 649 7776

www.martin-audio.com

All information is Copyright © 2018 Martin Audio Ltd.

Martin Audio, the Martin Audio logo and Hybrid are registered trademarks of Martin Audio Ltd. in the United Kingdom, United States and other countries; all other Martin Audio trademarks are the property of Martin Audio Ltd.



Unite Your Audience
The Martin Audio Experience

Version 1.2