

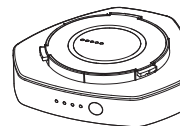

**WIRELESS SPEAKER  
BATTERY FOR HEOS 1**

# Owner's Manual

**HEOS 3 HS2  
HEOS 1 HS2  
HEOS 1 Go Pack HS2 (Sold Separately)**

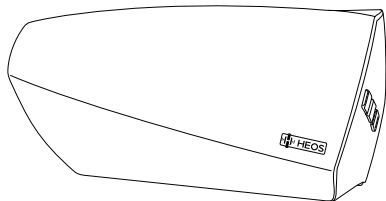

<b>Introduction</b>	<b>6</b>	<b>Using your HEOS speaker</b>	<b>19</b>
<b>Before your begin</b>	<b>7</b>	Selecting a room/speaker	19
System requirements	7	Listening to radio	20
Network requirements	7	Playing music stored on your mobile device	20
Controller requirements	8	Playing music from your networked PC or NAS	21
Getting to know your HEOS speaker	9	Playing music from the AUX input	22
Getting to know your battery (sold separately)	10	Playing music from a USB device	23
Part names and functions	11	Playing music from Bluetooth device	24
Front panel	11	Pairing the HEOS speaker with your Bluetooth devices	24
Controls	12	HEOS account	25
Back panel	13	What is a HEOS account?	25
Placing your HEOS speaker	15	Why do I need a HEOS account?	25
Wall or ceiling mounting	15	Signing up for a HEOS account	25
Powering your HEOS speaker	16	Changing your HEOS account	25
Getting the HEOS app	16	Playing from streaming music services	26
<b>Setting up your first HEOS speaker</b>	<b>17</b>	Adding a music service	26
<b>Adding more HEOS devices</b>	<b>18</b>	Changing music service settings	26
Adding wired HEOS devices	18	Managing inputs	27
Adding wireless HEOS devices	18	Changing the name of the inputs	27
		Hiding an input	27
		Managing your phone	28
		Listening to the same music in multiple rooms	29
		Grouping rooms	29
		Ungrouping rooms	30
		Grouping all rooms (party mode)	31
		Ungrouping all rooms	32
		Stereo pairing	33
		Creating a stereo pair	33
		Changing the name of a stereo pair	35



Adjusting the balance	35
Swapping left and right channels in a stereo pair	36
Removing a stereo pair	36
Using the now playing queue	37
Play Now	37
Play Now & Replace Queue	37
Play Next	37
Add to End of Queue	37
Rearranging the now playing queue	38
Deleting songs from the play queue	38
Deleting all songs from the play queue	39
Saving playlists	39
Performing repeat and shuffle playback	39
Using the favorite	40
Adding to HEOS favorite	40
Deleting station from the HEOS favorite	40

<b>Making speaker adjustments</b>	<b>41</b>
Changing the name of a speaker	41
Changing the wireless network connection	41
Changing the speaker's equalizer	42
Changing the speaker's orientation (HEOS 3 only)	42
Adjusting the audio quality	42
Adjusting the status light brightness	42
Advanced speaker settings	43
Network settings	43
About wireless power saving	43
Firmware upgrade	44
About	44



<b>Updating your system</b>	<b>45</b>
<b>Advanced features</b>	<b>46</b>
Sharing music from your mobile device	46
Wireless performance	46
Submit diagnostics	47
Resetting your controller app	47
<b>Power management</b>	<b>48</b>
Power modes	48
Quick Start Mode	48
Deep Standby	48
Off	48
<b>Setting up HEOS 1 Go Pack</b>	<b>49</b>
Connecting the battery	49
Charging the battery	50
Connecting the Splashguard	50
Close splashguard	51
Turning off/on the battery	51
<b>Basic troubleshooting</b>	<b>52</b>
My speaker won't connect to my network using the audio cable	52
The front LED of HEOS 1 flashes repeatedly	52
Cannot pair a Bluetooth mobile device with the HEOS device	53
Cannot hear Bluetooth music	54
Cannot attach battery (HEOS 1 only)	54
Music cuts out or delays sometimes	55
I hear a delay when using the AUX input with my TV	55
I hear distortion when using the AUX input	56
Connecting to a WPS network	56
Resetting your speaker	57
Restoring the speaker to factory defaults	57



<b>Status LED table</b>	<b>59</b>
Battery indicator of HEOS 1 Go Pack	67
When connected to the AC charger/power supply (charging)	67
When running on battery power	67
<b>Supported file types and codecs</b>	<b>68</b>
<b>Specifications</b>	<b>69</b>
Speaker specifications	69
HEOS 3	69
HEOS 1	71
<b>Information</b>	<b>73</b>
Trademarks	73



Thank you for purchasing this HEOS product. To ensure proper operation, please read this owner's manual carefully before using the product.

#### NOTE

- THIS DOCUMENT CONTAINS INFORMATION THAT IS SUBJECT TO CHANGE WITHOUT NOTICE.  
For latest information, please visit <http://www.HEOSbyDenon.com>

## Introduction

The HEOS speaker is part of the HEOS wireless multi-room sound system that enables you to enjoy your favorite music anywhere and everywhere around your home. By utilizing your existing home network and the HEOS app on your iOS or Android™ device, you can explore, browse, and play music from your own music library or from many online streaming music services.

- True multi-room audio - play different songs in different rooms or the same song in every room
- Utilizes your existing home wireless network for quick and easy setup
- Industry leading microsecond audio synchronization between HEOS device
- Legendary Denon audio quality
- If you are in a hurry, you can be enjoying great sounding music in no time by following the steps outlined in the HEOS Quick Start Guide (packaged with your HEOS device).

#### [Example] HEOS 3



Please continue reading this Owner's Manual for more detailed information about the features and benefits of your HEOS Speaker.



# Before your begin

---

## NOTE

- If you have already installed at least one HEOS device, please skip to the section "Adding more HEOS devices" ( p. 18).

## System requirements

Before you begin installing your first HEOS speaker, please make sure you understand and meet a few basic requirements.

### ■ Network requirements

**Wireless Router** - In order to use your HEOS music system, you must have a working wireless (Wi-Fi) or ethernet network in your home. Even when connected to an Ethernet network, a Wi-Fi connection to the router is required to control the system using the HEOS Control app. If you do not have a wireless network, please contact your local Denon dealer or electronics retailer to assist you with purchasing and installing a wireless network in your home.

**High Speed Internet Connection** - HEOS accesses the Internet to stream music to your home from many popular online music services. HEOS is also designed to provide you with software updates, which are delivered via your home Internet connection. DSL, Cable, and Fiber services will provide the best experience and reliability. You may experience performance issues with slower Internet connections like satellite based services.



## ■ Controller requirements

You can control your HEOS wireless multi-room sound system using the free HEOS app on any iOS or Android mobile device that meets these minimum requirements:



### iOS Minimum Requirements

- iOS version 8.0 or later
- iPhone® 4S or newer
- iPad® 2 or newer
- iPod touch® (5th generation) or newer



### Android Minimum Requirements

- Android OS version 4.0 or later
- All resolutions





## Getting to know your HEOS speaker

Unpack your speaker from the box and verify that the following items are included:

HEOS Speaker

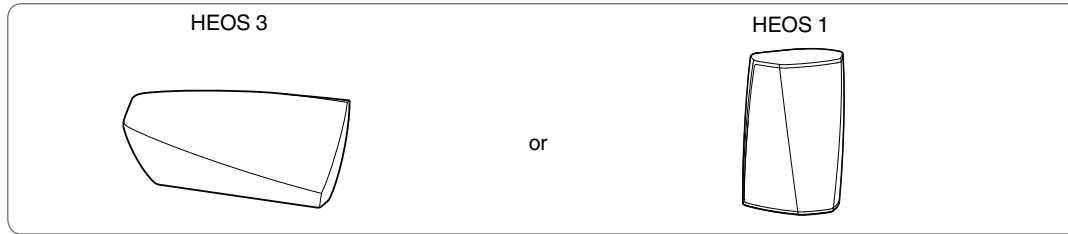

Quick Start Guide



Safety Instructions



Warranty  
(North America model only)



Extended Protection Plan  
(North America model only)



Audio/Setup cable



Ethernet cable

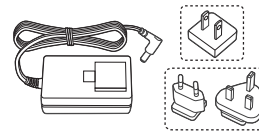

Power supply

(North America model only)

(European model only)

### NOTE

- Please use the power supply and power cord included in the box for your device.



## Getting to know your battery (sold separately)

Unpack your battery from the box and verify that the following items are included:

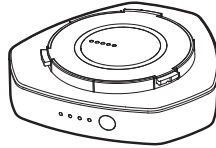

Rechargeable battery

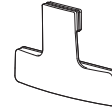

Splashguard



Quick Start Guide



Safety Instructions



Warranty  
(North America model only)



Extended Protection Plan  
(North America model only)



## Part names and functions

### ■ Front panel

HEOS 3

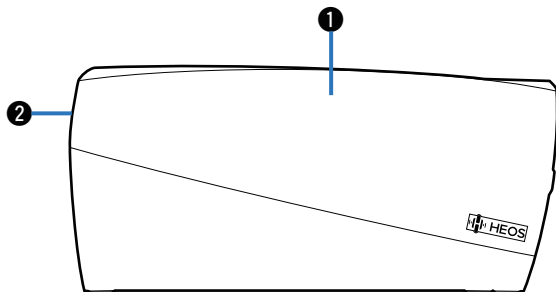

HEOS 1

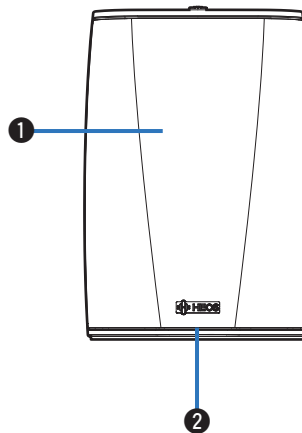

HEOS 1 + Go Pack

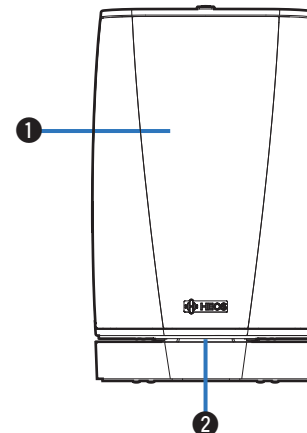

① Speakers

② Status LED

Please refer to the “Status LED table” for LED color and state meaning. (👉 p. 59)



## ■ Controls

HEOS 3

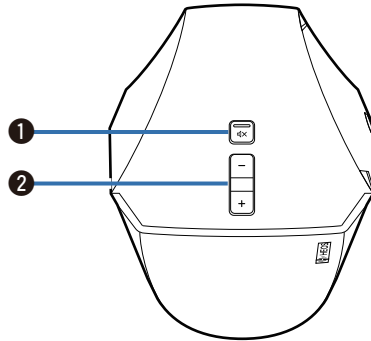

HEOS 1

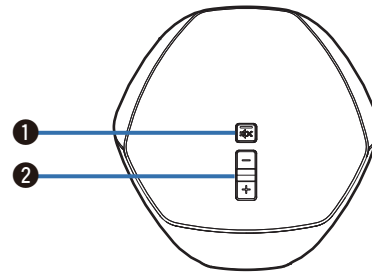

### ① Mute button (🔇)

Mutes or unmutes the HEOS device's volume.

### ② Volume up/down buttons (+, -)

Adjusts the HEOS device's volume level up or down.



## ■ Back panel

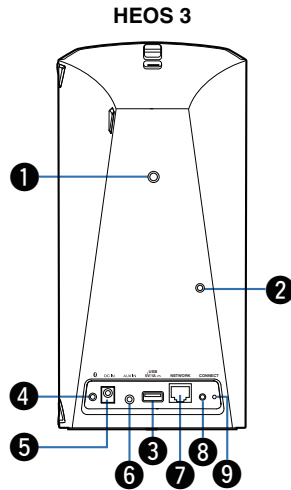

### ① Threaded Mounting Hole

Used to mount this unit on a wall or ceiling.

### ② Safety Wiring Hole

Used to prevent from dropping.

### ③ USB port

Used to connect USB storage devices.

HEOS 1

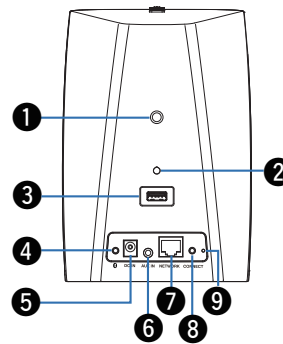

HEOS 1 + Go Pack

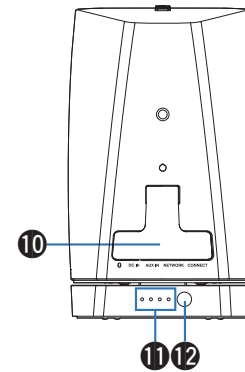

### ④ Bluetooth Button (Ⓞ)

Used in the Bluetooth pairing settings (👉 p. 24).

### ⑤ Power Input (DC IN)

Used to connect the external power supply (👉 p. 16).

### ⑥ AUX Input (AUX IN)

Used to connect audio devices (👉 p. 22).

Used to add the speaker to your wireless network (👉 p. 18).



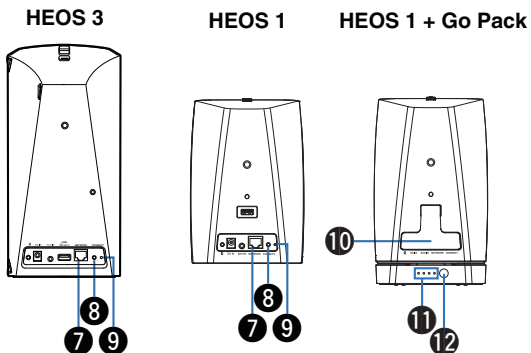

### 7 Network Connector (NETWORK)

Used to connect this unit to a wired Ethernet network (👉 p. 18).

### 8 Connect Button (CONNECT)

Used for Wi-Fi setup (👉 p. 56).

### 9 Connect in Status LED

Indicates the status of this unit (👉 p. 59).

### 10 Cap

Close this cap securely to maintain the splash-proof capabilities.

### 11 Battery/Charging Indicator

Indicates the amount of remaining battery power and charging status.

### 12 Status Button (⏻)

- Used to check the amount of remaining battery power (👉 p. 67).
- Turning off/on the battery (👉 p. 51).



## Placing your HEOS speaker

You can place your HEOS device anywhere you want to enjoy great sounding music. Please follow these simple guidelines when determining where to place your speaker...

- The HEOS speaker must be within range of your wireless network.
- The HEOS speaker is designed to sound best when placed 3 to 12 inches (8 - 30 cm) from a wall.
- Locate the speaker at least 12 inches (30 cm) from a television, computer, or other display device to avoid the possibility of interference.
- Place the speaker across the room from where you will be listening, as close to ear level as possible.
- The HEOS speaker is not waterproof. Do not place it near any water source and do not leave it outside in the rain or snow.

### ■ Wall or ceiling mounting

The HEOS speaker can optionally be mounted on a wall or ceiling using standard 1/4 inches (6.35 mm) (Screw hole length) threaded speaker or camera mounts which support up to 14 lbs 16 oz (6.8 kg). Please visit your local Denon dealer or electronics retailer for more information about possible wall and ceiling mounting options.

#### Caution

- Recommend installing a safety wire (not included) at the safety wiring hole on the back of the speaker in order to prevent injury to the user and others or damage to property should the speaker fall for some reason.
- Use a commercial bracket (not included) to attach this unit to the wall or ceiling. Do not attach it directly to the wall or ceiling.
- If attaching this unit to the wall or ceiling, check that it is attached securely. Please be aware that Denon accepts no responsibility for any damage if the unit falls.



## Powering your HEOS speaker

Connect the power cord included in the box to the back of the speaker and the plug to a wall outlet. The speaker is capable of automatically switching between 100 - 240 V.

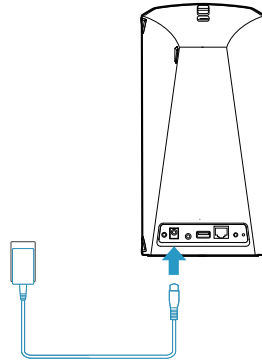
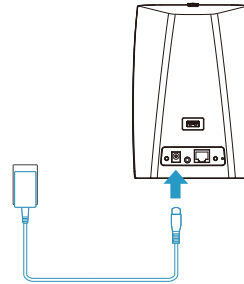
**HEOS 3****HEOS 1**

## Getting the HEOS app

The HEOS app is the heart of the HEOS experience. Using your mobile device and the HEOS app, you can setup, browse, explore, and control your HEOS system right in the palm of your hand, from anywhere in your home.

Download the HEOS app for iOS or Android by searching App Store®, Google Play™ store or Amazon App Store for “HEOS”.



For the purpose of improvement, the specifications and design are subject to change without notice.





# Setting up your first HEOS speaker

Once you have placed your speaker in your listening room and have downloaded the HEOS app, you are ready to configure your speaker for music playback. This involves following a few simple steps to get the speaker connected to your existing home network:

## Caution

- DO NOT connect the Ethernet cable if you are connecting your speaker to a wireless network. If you are connecting the speaker to a wired network, use an Ethernet cable to connect the speaker to your network or router.

## 1 Make sure your mobile device is connected to your wireless network (the same network you want your speakers connected to).

You can check this in the Settings - Wi-Fi menu of your iOS or Android device.

## NOTE

- If your wireless network is secure, make sure you know the password to join your network.

## 2 Make sure you have the included Audio/Setup cable handy.

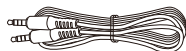

## 3 Launch the HEOS app on your mobile device.



## 4 Tap the “Setup Now” button at the top of the screen.

## 5 Follow the instructions to add the speaker to your wireless network.

The Wi-Fi settings from your mobile device will be copied to the speaker via the audio cable.

## NOTE

- If you have any problems connecting your HEOS device, jump to the Troubleshooting section ([↩ p. 52](#)).



## Adding more HEOS devices

The HEOS wireless multi-room sound system is a true multiroom audio system that automatically synchronizes audio playback between multiple HEOS devices so that the audio coming from different rooms is perfectly in sync and always sounds amazing! You can easily add up to 32 HEOS devices to your HEOS system.

### Adding wired HEOS devices

Just connect the HEOS device to your home network using an Ethernet cable and the HEOS device will appear on your HEOS app as a new room in the Rooms screen.

At your convenience, you can assign a name to the HEOS device to indicate which room you have it placed in.



- Use only a shielded STP or ScTP LAN cable which is easily available at electronics stores (CAT-5 or greater recommended).
- Do not connect a Network Connector directly to the LAN port/Ethernet connector on your computer.

### Adding wireless HEOS devices

You can add additional wireless HEOS devices to your HEOS system by selecting “Add Device” from the HEOS app’s settings menu and follow the instructions:

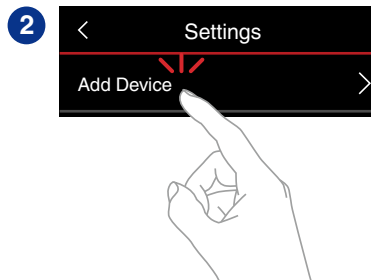
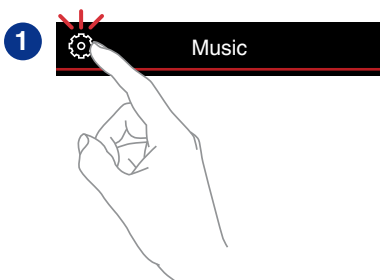

## Using your HEOS speaker

Once you have your HEOS device connected to your network and the HEOS app installed on your mobile device, it's easy to start enjoying your favorite music. You can listen to something different on every HEOS device or the same music perfectly synchronized on all HEOS devices. It's up to you!

### Selecting a room/speaker

If you have more than one HEOS device, you must tell the HEOS system which HEOS device you want to control:

- 1 Tap the “Rooms” tab.
- 2 Select the Room/Speaker you want to control.
- 3 Select the “Music” tab to select a music source or the “Now Playing” tab to control what is currently playing in the selected room.

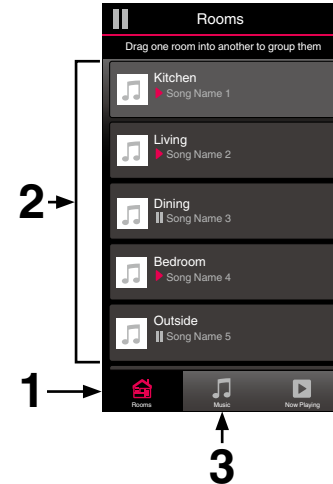

## Listening to radio

The HEOS system includes access to more than 100,000 free internet radio streams from all corners of the globe via the TuneIn radio service. Just select the TuneIn logo from the main “Music” menu and browse among the 100,000 stations neatly organized into popular categories and select a station that appeals to your mood.

### NOTE

- If you have a TuneIn account, you can sign into the TuneIn service under “Settings” - “Music Sources” - TuneIn, and access all of your “My Favorites” TuneIn stations.

■ ■ ■ Audio signal

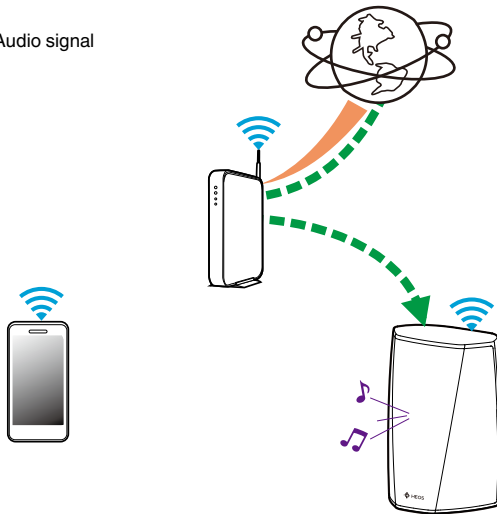

## Playing music stored on your mobile device

- 1 Tap the “Music” tab.
- 2 Select “This iPhone/iPod/iPad/Phone”.
- 3 Browse the local music on your phone and select something to play.

■ ■ ■ Audio signal

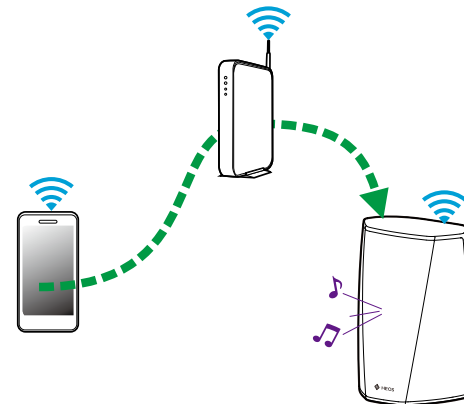

## Playing music from your networked PC or NAS

- 1 Select “Music Servers” from the “Music” tab.
- 2 Select the name of your networked PC or NAS (Network Attached Storage) server.
- 3 Browse the music on your PC/NAS and select something to play.

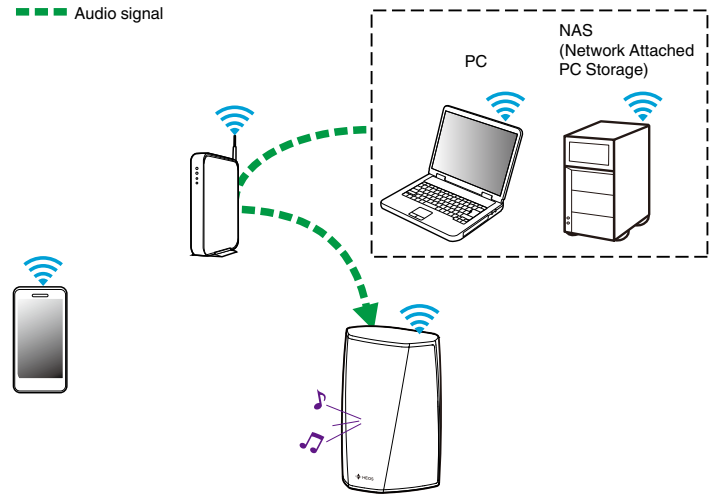

## Playing music from the AUX input

### 1 Connect an audio device with a 3.5 mm stereo audio output to the AUX input on your speaker using the included 3.5 mm stereo audio cable.

When a stereo audio cable is connected to AUX IN, the source automatically switches to Inputs.

#### NOTE

- When there is a cable connected to AUX IN, select “Inputs” from the “Music” tab.

### 2 Initiate playback on the audio device.



- The sound from the audio device can be played directly on the selected speaker or digitized and sent over your network to other speakers.

#### NOTE

- The analog output signals from some sources can be fairly strong. If the input level of the source device is turned up high, it could overload the inputs of the HEOS device.

This is unlikely to cause damage, but can cause distorted sound. Initially, set the volume of the source to a medium – low level, then turn it up as needed. If you hear distortion, turn down the device's volume control.

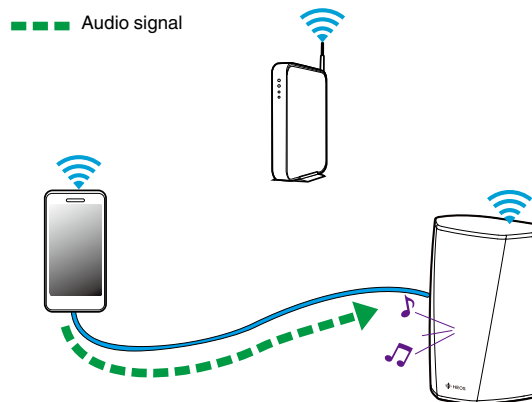

## Playing music from a USB device

- 1** Insert a FAT32 formatted USB device into the USB port on the back of the HEOS speaker.
- 2** Select “USB Music” from the “Music” tab.
- 3** Select the name of your HEOS speaker.
- 4** Browse the music on your USB device and select something to play.

### NOTE

- It may take several minutes for the name of your HEOS device to appear in the “USB Music” list if you have a large number of files on your USB device.
- It is not possible to connect and use a computer via the USB port of this unit using a USB cable.

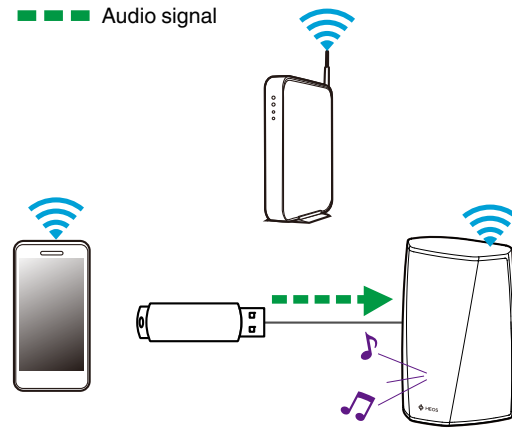

## Playing music from Bluetooth device

### ■ Pairing the HEOS speaker with your Bluetooth devices

- 1** Activate the Bluetooth setting on your mobile device.
- 2** Press and hold the Bluetooth button (📶) located on the back of the HEOS speaker for 3 seconds and release the button when you see a pattern of two green flashes on the status LED.
- 3** Select “HEOS speaker” from the list of available Bluetooth devices.  
In a few seconds your mobile device will indicate that it is connected to your speaker.
- 4** Play music using any app on your device.  
The sound will now play from the HEOS speaker.

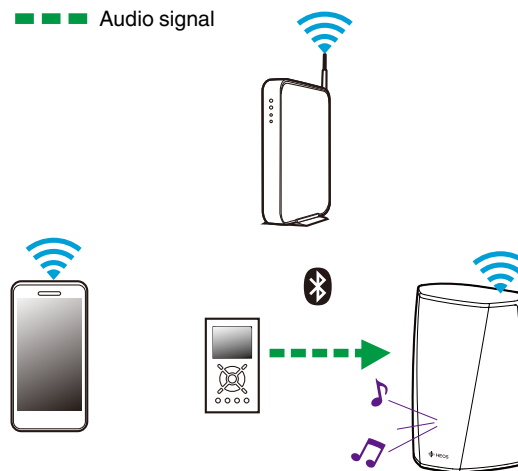

#### NOTE

- Disconnect and reconnect Bluetooth connections from your Bluetooth device.





## HEOS account

### ■ What is a HEOS account?

A HEOS account is master account or “keychain” for managing all of your HEOS music services with one single username and password.

### ■ Why do I need a HEOS account?

With the HEOS account you just have to enter your music services login names and passwords one time. This allows you to easily and quickly use multiple controller apps on different devices. You just log into your HEOS account on any device and you will have access to all of your associated music services, play history and custom playlists, even if you are at a friend’s house listening to music on their HEOS system.

### ■ Signing up for a HEOS account

You will be instructed to signup for a HEOS account the first time you try to access any music service from the main “Music” menu of the HEOS app.

### ■ Changing your HEOS account

- 1 Tap the “Music” tab.
- 2 Select the Settings  icon in the upper left corner of the screen.
- 3 Select “HEOS Account”.
- 4 Change your location, change your password, delete your account or sign out of your account.



## Playing from streaming music services

A music service is an online music company that provides access to vast music collections via free and/or paid subscriptions. Depending upon your geographical location, there are several options to choose from. For more information about which services are available in your area please visit <http://www.HEOSbyDenon.com>

### ■ Adding a music service

Once you've setup your HEOS account, you can add supported music services to your HEOS system by tapping on the music service logo in the "Music" tab.

Follow the instructions on the screen to add your username and password for the selected music service. You only have to enter your account information once as the HEOS account service will securely remember your login information so you don't have to enter it each time you want to play music from the music service.

Additional music services may be available under "Settings" - "Music Sources" - "Online Music".

### ■ Changing music service settings

- 1 Tap the "Music" tab.
- 2 Select the Settings  icon in the upper left corner of the screen.
- 3 Select "Music Sources".
- 4 Select "Online Music".
- 5 Select the name of the online music service you want to edit.
- 6 Sign out, then sign in again to associate your username and password with your HEOS account.
- 7 Select "Hide for Now" to prevent the service logo from appearing on the main "Music" menu.



## Managing inputs

If you connected external audio source components to any of your HEOS speakers inputs, you can rename the default input names to describe the actual source or hide any inputs that are not being used.

- 1** Select the Settings  icon located in the upper left corner of the main “Music” menu to display the Settings menu.
- 2** Select “Music Sources”.
- 3** Select “Inputs”.
- 4** Select the speaker which you connect your external audio source device to.

### ■ Changing the name of the inputs

- 1** Select the name of the input you want to edit.
- 2** Select “Name”.
- 3** Select or enter a new name to describe the source that you connected.
- 4** Select the Save button to save your changes.

### ■ Hiding an input

- 1** Select the name of the input you want to edit.
- 2** Toggle “Hide Input” to ON to prevent this input from appearing under the Inputs tile on the main “Music” menu.



## Managing your phone

Your smartphone or tablet can be hidden if it does not need to be in the “Music Sources” menu.

- 1** Select the **Settings**  icon located in the upper left corner of the main “Music” menu to display the Settings menu.
- 2** Select “Music Sources”.
- 3** Select “This iPhone/iPod/iPad/Phone”.
- 4** Toggle “This iPhone/iPod/iPad/Phone” to OFF to prevent the service logo from appearing on the main “Music” menu.



## Listening to the same music in multiple rooms

The HEOS system is a true multiroom audio system that automatically synchronizes audio playback between multiple HEOS devices so that the audio coming from different rooms is perfectly in sync and always sounds amazing!

You can easily add up to 32 HEOS devices to your HEOS system.

You can join or group up to 16 individual HEOS devices into a group of HEOS devices that function as if they were a single HEOS device.

### ■ Grouping rooms

- 1 Tap the “Rooms” tab.
- 2 Press and hold your finger on room that is not playing music.
- 3 Drag it into the room that is playing music (indicated by the red outline) and lift your finger.

The two rooms will be grouped together into a single device group and both rooms will be playing the same music in perfect sync.

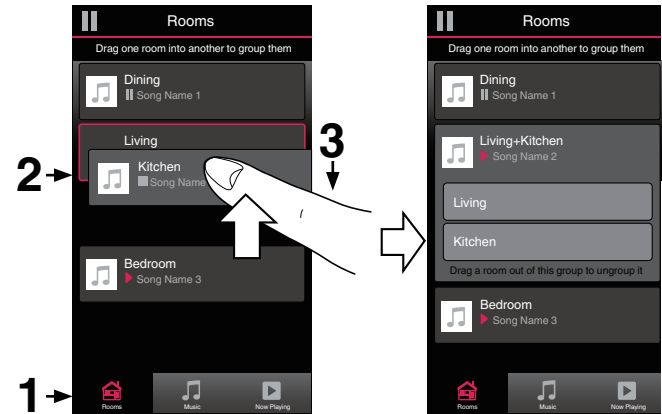

## ■ Ungrouping rooms

- 1 Tap the “Rooms” tab.
- 2 Press and hold your finger on room that you want to remove from the group.

### NOTE

- You can not remove the first room that started playing the music before grouping.

- 3 Drag it out of the group and lift your finger.  
Music will stop playing in the room you dragged out of the group but will continue playing in any remaining rooms.

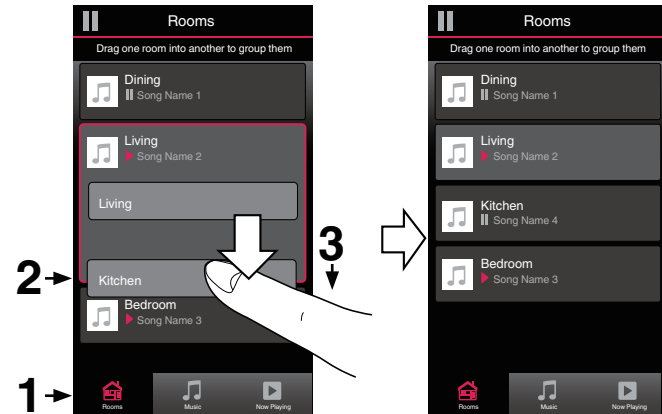

## ■ Grouping all rooms (party mode)

You can easily group 16 rooms together into Party Mode by using a “pinch” gesture.

- 1 Tap the “Rooms” tab.
- 2 Place two fingers on the screen over the list of rooms.
- 3 Quickly pinch your two fingers together and release.

All of your rooms will be joined together and begin playing the same music in perfect sync.

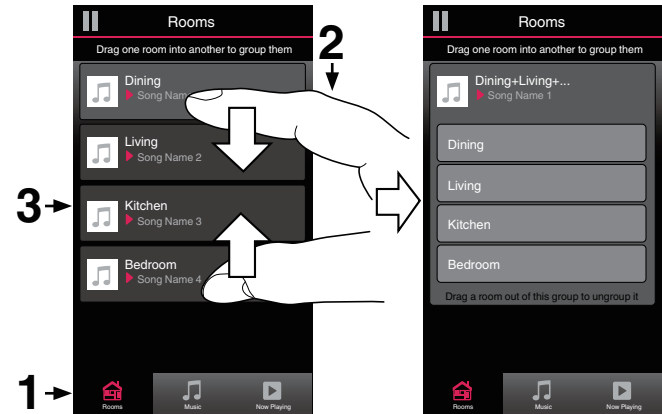

## ■ Ungrouping all rooms

You can easily ungroup all of your rooms and exit Party Mode by using a “spread” gesture.

- 1 Tap the “Rooms” tab.
- 2 Place two fingers close together on the screen over list of rooms.
- 3 Quickly spread your two fingers apart from each other and release.

All of your rooms will be ungrouped and music will stop playing in every room (except the original “master” room that was playing before you grouped the rooms together).

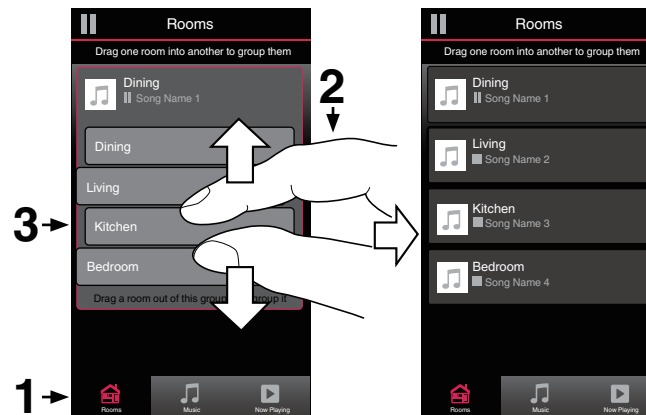



## Stereo pairing

### ■ Creating a stereo pair

A matching pair of HEOS 1 or HEOS 3 speakers that have been grouped together (see above) can be saved as a persistent stereo pair where one speaker outputs the left channel of audio and the other speaker outputs the right channel of audio. Paired speakers will then appear as a single room (with two speakers playing music) in the Rooms list.

- 1 Tap the “Rooms” tab.
- 2 Create a group containing **ONLY two matching speakers** (see “Grouping rooms” (🔗 p. 29)).
- 3 Tap the Pencil 🖋 icon to enter Edit mode.
- 4 Tap on the Group of two matching speakers to Edit the Group.

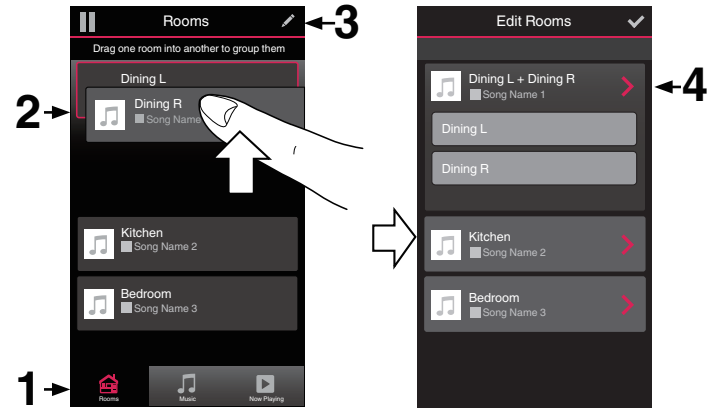

**5** Tap on the Stereo Pair switch to pair the two speakers.



**6** Tap the Back arrow  to return to the list of Rooms.

**7** Tap the Check Mark  icon to exit Edit mode.

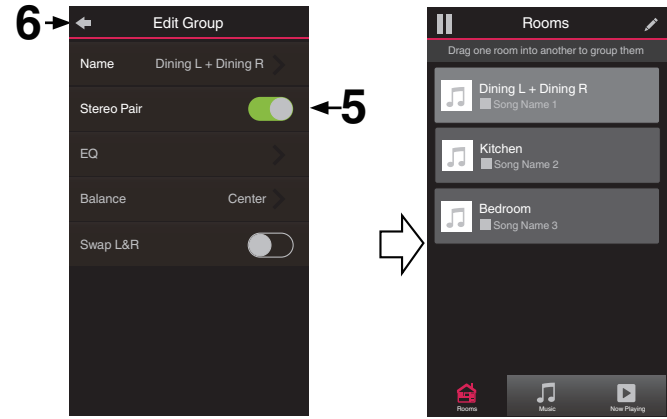

The group of two matching speakers will now appear as a single room. You can change the name of the stereo paired room at any time.



## ■ Changing the name of a stereo pair



- 1 Tap the “Rooms” tab.
- 2 Tap the Pencil  icon to enter Edit mode.
- 3 Tap a Stereo Pair (a room which contains two matching HEOS speakers) to edit the group.
- 4 Tap “Name”.
- 5 Select or enter a new name for your pair of speakers.
- 6 Tap the Save  button to save your changes.

## ■ Adjusting the balance



- 1 Tap the “Rooms” tab.
- 2 Tap the Pencil  icon to enter Edit mode.
- 3 Tap a Stereo Pair (a room which contains two matching HEOS speakers) to edit the group.
- 4 Select “Balance”.
- 5 Adjust the Balance to the left or right.
- 6 Tap the Check Mark  icon to exit Edit mode.



## ■ Swapping left and right channels in a stereo pair

- 1 Tap the “Rooms” tab.
- 2 Tap the Pencil  icon to enter Edit mode.
- 3 Tap a Stereo Pair (a room which contains two matching HEOS speakers) to edit the group.
- 4 Tap on the Swap L&R switch to swap the left and right channels of the two speakers.
- 5 Tap the Back arrow  to return to the list of Rooms.
- 6 Tap the Check Mark  icon to exit Edit mode.

## ■ Removing a stereo pair

- 1 Tap the “Rooms” tab.
- 2 Tap the Pencil  icon to enter Edit mode.
- 3 Tap a Stereo Pair (a room which contains two matching HEOS speakers) to edit the group.
- 4 Tap on the Stereo Pair switch to return the paired speakers to two individual speakers.
- 5 Tap the Back arrow  to return to the list of Rooms.
- 6 Tap the Check Mark  icon to exit Edit mode.



## Using the now playing queue

HEOS uses a Now Playing “Queue” to line up music that you want to listen to. Music can be selected from any of your local or online music sources (as long as they are not preprogrammed “radio” or “station” type streams). This feature works similarly to how a jukebox works. You select something to play (a song, album, playlist or even your entire music collection) and add it to the “Queue”. When you select something to play you will be asked how you want to queue up your music.

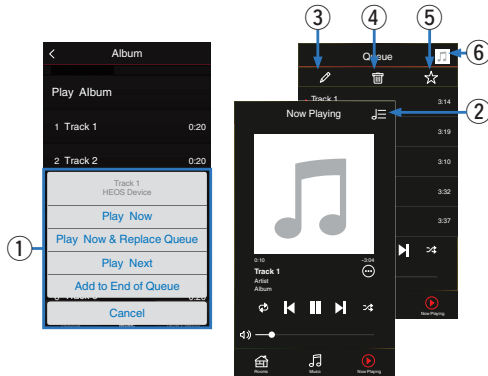

### 1 Queue Menu

When you select something to play you will be asked how you want to queue up your music.

### 2 Queue icon

### 3 Pencil icon

### 4 Delete icon

### 5 Save icon

### 6 Cover art or HEOS icon

You can return to the “Now Playing” screen display by tapping the cover art or the HEOS icon.

### ■ Play Now

Inserts the item into the queue after the currently playing track and plays the selected item immediately.

### ■ Play Now & Replace Queue

Clears the queue and plays the selected item immediately.

### ■ Play Next

Inserts the item into the queue after the current song and plays it when the current song ends.



### ■ Add to End of Queue

Adds the item to the end of the queue.





## Rearranging the now playing queue

Once you have songs lined up in your queue, you might want to rearrange the order or remove some songs:

- 1 Tap the “Now Playing” tab.
- 2 Tap the Queue  icon in the upper right corner of the screen.
- 3 Tap the Pencil  icon to enter Edit mode.
- 4 Rearrange the order of your queue by dragging the list  icon (on the right side of each track row) up or down.

## Deleting songs from the play queue



You can remove songs one at a time from the Now Playing Queue:

- 1 Tap the “Now Playing” tab.
- 2 Tap the Queue  icon in the upper right corner of the screen.
- 3 Tap the Pencil  icon to enter Edit mode.
- 4 Tap the track(s) that you want to delete.
- 5 Tap the Delete  icon to delete all of the selected tracks from the play queue.





## Deleting all songs from the play queue

You can remove all of the songs from the Now Playing Queue:

- 1 Tap the “Now Playing” tab.
- 2 Tap the Queue  icon in the upper right corner of the screen.
- 3 Tap the Delete  icon to confirm that you want to delete all songs from the queue.



## Saving playlists

You can save the Now Playing Queue as a HEOS Playlist that you can recall later. The new playlist will be available from the Playlists button on the “Music” tab on every controller app connected to your HEOS system.

- 1 Tap the “Now Playing” tab.
- 2 Tap the Queue  icon in the upper right corner of the screen.
- 3 Tap on the Save  icon.
- 4 Enter a name for your Playlist and tap the  icon.

## Performing repeat and shuffle playback

The playback controls are visible on the “Now Playing” screen.

- 1 Tap the “Now Playing” tab.
- 2 Tap the repeat  and shuffle  controls.



## Using the favorite

HEOS uses a "HEOS Favorites" to line up station you want to start play quickly the favorite stations. Station can be selected from online music sources such as "Radio" or "Station" type streams. "HEOS Favorites" will display a list of the stations of various services.

### ■ Adding to HEOS favorite

Select a station of an online music source. When the action menu screen is displayed, select "Add Station to HEOS Favorites".

#### NOTE

- This can also be done by selecting "Add Station to HEOS Favorites" from the station menu of the station being played.

### ■ Deleting station from the HEOS favorite

- 1 Tap the "Music" tab.
- 2 Select "Favorites".
- 3 Tap the Pencil  icon to enter Edit mode.
- 4 Tap the "Delete" that you want to delete station.





## Making speaker adjustments

You can adjust specific settings for each of your HEOS speakers in your system:

- 1** Select the **Settings**  icon located in the upper left corner of the main “Music” menu to display the Settings menu.
- 2** Select “My Devices” to display a list of your HEOS devices.
- 3** Select the speaker you want to adjust.

### Changing the name of a speaker

- 1** Select “Name”.
- 2** Select or enter a new name for your speaker.
- 3** Tap the  icon to save your changes.

### Changing the wireless network connection

- 1** Select “Network”.  
A list of wireless networks that your speaker can access is displayed.
- 2** Select the network you want your speaker to join.  
Wait as the speaker’s network connection is changed.

#### NOTE

- Wired networking is automatically selected when the speaker is connected to a wired Ethernet network. To switch back to using a wireless network you must remove the Ethernet cable from the back of the speaker.



## Changing the speaker's equalizer

- 1 Select “EQ”.
- 2 Adjust the “Treble” or “Bass” up or down.

### NOTE

- Select the Reset button to restore the default settings.

## Changing the speaker's orientation (HEOS 3 only)

The HEOS 3 can be placed both vertically and horizontally.

Each orientation has its own sound tuning and should be set accordingly for optimal sound quality.

- 1 Select “Orientation”.
- 2 Select “Vertical” if you placed your HEOS 3 vertically or select “Horizontal” if you placed your HEOS 3 horizontally.

Tap the Back arrow  and your settings are automatically saved.

## Adjusting the audio quality

Selects the transcoding option for rebroadcasting audio from one HEOS device to another HEOS device (or group of devices) across the network. When set to high bit rate audio sources originating from the first device (such as analog input, WAV, FLAC and PCM) will be transcoded to ensure the highest level of reliability for the audio stream.

- 1 Select “Quality”.
- 2 Select Normal (default) or High.



- If you have selected High and you experience audio dropouts when streaming sources from one device to other devices, please select Normal (default).

## Adjusting the status light brightness

- 1 Select “Status Light”.
- 2 Adjust the brightness up or down or set the slider to the OFF position to completely disable the status light.



## Advanced speaker settings

### Caution

- Adjusting these settings may disconnect your speaker from your network and possibly render your speaker unusable. Do not use these features unless you are comfortable making advanced adjustments to your speaker.

### ■ Network settings

- 1 Select “Advanced”.
- 2 Select “NETWORK SETTINGS” tab.
- 3 Scroll down to see all of the options for
  - a. Network Interface (Ethernet or Wireless)
  - b. Wireless Settings
  - c. IP Address Settings (Automatic or Manual)
  - d. Wireless Power Saving
- 4 Select “Save Settings” to apply the new settings or “Cancel Changes” to revert to the previous settings.

### ■ About wireless power saving

The Wireless Power Savings feature saves power by turning off power to the wireless radio inside the HEOS device when the device is connected to an Ethernet network. If you disconnect the Ethernet cable from the HEOS device, Wireless Power Saving will automatically turn off and the wireless radio will turn on so that the HEOS device can be discovered over your wireless network.

### NOTE

- If Wireless Power Savings is ON, Wi-Fi power will be temporarily turned on when accessing the My Devices - (My Devices) - Network screen in the HEOS app or whenever the Connect button on the device is pressed.



## ■ Firmware upgrade

- 1 Select “Advanced”.
- 2 Select “FIRMWARE UPDATE” tab.
  - Update status

---

  - Manually check for a firmware upgrade.

---

  - Allow updates

---

  - ON (Default): Allows updates

---

  - OFF: Does not allow updates

---
- 3 Select “Save Settings” to apply the new settings or “Cancel Changes” to revert to the previous settings.

## ■ About

Viewing technical details about the HEOS device.

- 1 Select “Advanced”.
- 2 Select “ABOUT” tab.
- 3 Scroll down to see information about the speaker’s.
  - a. Hardware
  - b. Software
  - c. Device



# Updating your system

HEOS has the ability to add enhancements and updated functionality via your high speed Internet connection. Follow the instructions on the screen to update the HEOS device and/or your controller App.

- 1** Select the Settings  icon located in the upper left corner of the main “Music” menu to display the Settings menu.
- 2** Select “Software Update”.

## Check for Update

---

Follow the instructions on screen to install any available updates to your HEOS system.

---

## Auto-Update

---

**ON (Default):** Valid updates are performed automatically.

---

**OFF:** You will be notified of valid updates on the HEOS app.

---



## Advanced features

There are a few advanced features of the HEOS system that you may want to explore once you become familiar with the basic operations. You can access the advanced features of the HEOS system by following these steps:

- 1** Select the **Settings**  icon located in the upper left corner of the main “Music” menu to display the **Settings** menu.
- 2** Select “**Advanced Settings**” to display a list the available settings.

### Sharing music from your mobile device

The HEOS app has a feature called “Music Sharing” which can share the local music stored on your mobile device to other HEOS app users on your local network. To enable this feature, select “Music Sharing”, and set it on “ON”.

The name of the device you are sharing from will appear as a music server allowing other HEOS controller apps to browse and play music from the your device.

### Wireless performance

You can check the wireless connection status of your HEOS device.

#### Quality

---

**Excellent / Good / Poor**

---

#### NOTE

- If the quality level of your HEOS device is “Poor”, make sure your HEOS devices are not located near other electronic devices that could interfere with it’s wireless connectivity (like microwave ovens, cordless phones, TVs, etc...)

#### Signal

---

**Excellent / Good / Poor**

---

#### NOTE

- If the signal level of your HEOS device is “Poor”, make sure your HEOS devices are within range of your wireless network.



## Submit diagnostics

If you are having trouble with your network or HEOS system, you may be asked by Denon technical support personnel to select this option. This feature will automatically send Denon technical support diagnostic information about your HEOS system.

### NOTE

- No personal information is sent and your information will never be shared with anyone.

## Resetting your controller app

This feature will reset the control app to its original state when you first installed it on your mobile device without requiring you to remove, download, and reinstall it from the app store.



# Power management

## Power modes

### ■ Quick Start Mode

HEOS device automatically enters "Quick Start Mode" to save power in the following cases. This unit will automatically resume to full power whenever the device is selected and playing music.

The status LED dims when the mode is switched to Quick Start Mode.

#### □ Ethernet

After around 20 minutes of no operation and no network access after playing music via Ethernet.

#### □ Wi-Fi

After around 20 minutes of no operation and no network access after playing music via Wi-Fi.

#### □ USB

After around 20 minutes of no operation and no network access after playing music from a USB memory device.

#### □ Bluetooth

After the Bluetooth connection is disconnected and there is around 20 minutes of no operation and no network access after playing music via Bluetooth.

#### □ AUX IN

After around 20 minutes of no operation after AUX cable is disconnected.

### ■ Deep Standby

The device also has the ability to automatically enter "Deep Standby" whenever the wired or wireless network connection is removed for more than 60 minutes in "Quick Start Mode". The front panel LED will turn off during Deep Standby.

To "wake" a HEOS device from Deep Standby, you must press the volume or mute buttons which will immediately turn on the front panel LED.



- You also push the mute button for 3 seconds, the device enters the Deep Standby.

### ■ Off

To completely turn off the power to the device you must remove the mains plug from the power outlet.





## Setting up HEOS 1 Go Pack

Before using a new HEOS 1 speaker with HEOS 1 Go Pack, we recommend you first connect your HEOS 1 speaker to your home network to get the latest speaker updates and newest features.

### Connecting the battery

- 1** Remove the cap from the bottom of the HEOS 1 speaker by turning the cap counter-clockwise and pulling it away from the speaker.

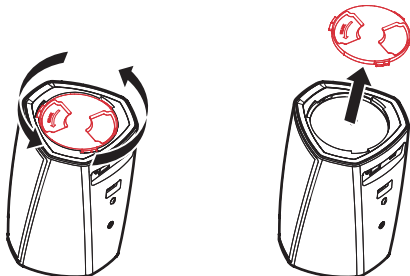

- 2** Align the red dots on the top of the battery and bottom of the speaker.

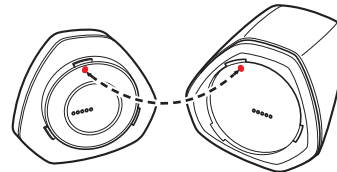

- 3** Turn the battery clockwise so that it is aligned with the shape of the speaker.

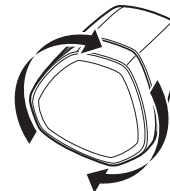

## Charging the battery

To charge the battery, connect the HEOS 1 power adapter between the speaker and a wall outlet.

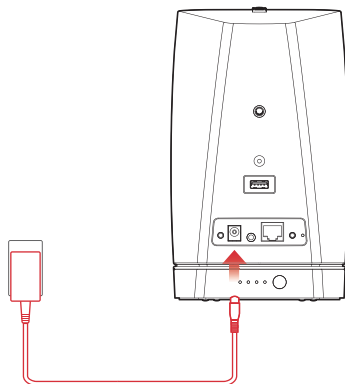

- It takes at least 3.5 hours to fully charge the battery when it is completely discharged. (“Battery indicator of HEOS 1 Go Pack” (🔗 p. 67))
- HEOS 1 Go Pack can be used for approximately 6 hours when the battery is fully charged. (The playback time may differ depending on the ambient temperature, playback volume, and usage conditions)

## Connecting the Splashguard

Once your battery is fully charged, attach the Splashguard to the back of the speaker.

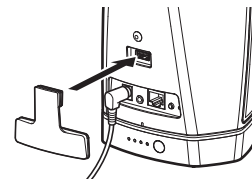

- “Playing music from the AUX input” (🔗 p. 22)
- “Playing music from a USB device” (🔗 p. 23)
- “Playing music from Bluetooth device” (🔗 p. 24)



## Close splashguard

- 1 Remove the power connector from the speaker.
- 2 Press in the Splashguard so that it is firmly and evenly attached.

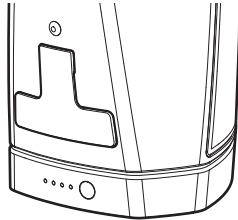

Properly attaching the splashguard will make your HEOS 1 speaker waterproof to the IPX4 standard. **DO NOT** submerge the speaker in water!

## Turning off/on the battery

To turn off the battery, press and hold the button on the back of the battery for 2 seconds. The LEDs will flash quickly then turn off, indicating that the battery is off.

Turning off the battery will conserve battery power while you are not playing music and HEOS 1 is not plugged in to AC power.

To turn the battery back on, press and hold the button again for 2 seconds.

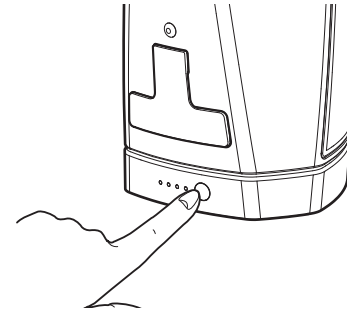

### NOTE

- While the battery is disconnected from HEOS 1, it is always off.



## Basic troubleshooting

### My speaker won't connect to my network using the audio cable

Solution	Refer to Page
<ul style="list-style-type: none"><li>• Make sure your mobile device is connected to your wireless network before setting up your speaker.</li></ul>	<u><a href="#">17</a></u>
<ul style="list-style-type: none"><li>• Alternatively, you can connect your speaker to your network router using the included Ethernet cable. Once connected via Ethernet, the HEOS App should recognize the speaker and you can manually move it to your wireless network using Settings/My Devices/Device_Name/Advanced/Network Settings.</li></ul>	<u><a href="#">18</a></u>

### The front LED of HEOS 1 flashes repeatedly

Solution	Refer to Page
<ul style="list-style-type: none"><li>• When the battery level is near zero the front LED of the HEOS 1 may flash repeatedly. This indicates that there is insufficient power in the battery to boot up the speaker. Please connect the AC adapter to the speaker which will charge the battery. The speaker can be used as normal while it is being charged.</li></ul>	<u><a href="#">50</a></u>



## Cannot pair a Bluetooth mobile device with the HEOS device

Solution	Refer to Page
<ul style="list-style-type: none"><li>The connection from the Bluetooth mobile device is malfunctioning. Power cycle the mobile device, remove the pairing information and re-pair the HEOS speaker to the mobile device.</li></ul>	-



## Cannot hear Bluetooth music

Solution	Refer to Page
<ul style="list-style-type: none"> <li>Your Bluetooth mobile device is not paired with HEOS speaker. Re-pair the HEOS speaker to the mobile device.</li> </ul>	—
<ul style="list-style-type: none"> <li>The HEOS speaker is Wi-Fi mode or Aux-in mode etc. Pair and connect Bluetooth device to HEOS speaker.</li> </ul>	—
<ul style="list-style-type: none"> <li>The Bluetooth mobile device is connected to another audio device. Make sure your Bluetooth device is connected to HEOS speaker.</li> </ul>	—
<ul style="list-style-type: none"> <li>The volume on Bluetooth mobile device is too low. Check the volume on the Bluetooth mobile device. Check the volume on the HEOS speaker.</li> </ul>	—
<ul style="list-style-type: none"> <li>HEOS 1 is off. Connect HEOS 1 to AC power or turn on the HEOS 1 battery by pressing battery power button for 2 seconds. Check the AC power outlet is working.</li> </ul>	—
<ul style="list-style-type: none"> <li>HEOS 1 battery is fully depleted. Check the battery gauge. Recharge the battery.</li> </ul>	<u>67</u>

## Cannot attach battery (HEOS 1 only)

Solution	Refer to Page
<ul style="list-style-type: none"> <li>Make sure bottom cover not is installed on HEOS 1 speaker.</li> </ul>	<u>49</u>
<ul style="list-style-type: none"> <li>Make sure no foreign object stuck in speaker/battery connection mechanism.</li> </ul>	—
<ul style="list-style-type: none"> <li>Be sure to line up red dots before attempting clockwise rotation to lock.</li> </ul>	<u>49</u>



## Music cuts out or delays sometimes

Solution	Refer to Page
<ul style="list-style-type: none"> <li>• Make sure your Internet connection is operating correctly. If you are sharing your network with other users or devices, they may be using most of your bandwidth (especially if they are streaming video).</li> </ul>	<u>7</u>
<ul style="list-style-type: none"> <li>• Make sure your speakers are within range of your wireless network.</li> </ul>	<u>46</u>
<ul style="list-style-type: none"> <li>• Make sure your speakers are not located near other electronic devices that could interfere with it's wireless connectivity (like microwave ovens, cordless phones, TVs, etc...).</li> </ul>	<u>46</u>

## I hear a delay when using the AUX input with my TV

Solution	Refer to Page
<ul style="list-style-type: none"> <li>• If you are connecting the AUX input with your cable or satellite box for enjoying TV audio through multiple HEOS speakers, you may hear a delay between when you see someone speak and when you hear the audio. This is because the HEOS system must buffer the audio before it sends it out to the speakers so that it arrives at all speakers at the same time.</li> </ul>	<u>22</u>
<ul style="list-style-type: none"> <li>• You can avoid this delay by listening only to the speaker which is directly connected to the set top box.</li> </ul>	—



## I hear distortion when using the AUX input

Solution	Refer to Page
<ul style="list-style-type: none"> <li>The analog output signals from some sources can be fairly strong. If the input level of the source device is turned up high, it could overload the inputs of the HEOS device. This is unlikely to cause damage, but can cause distorted sound. Initially, set the volume of the source to a medium – low level, then turn it up as needed. If you hear distortion, turn down the device's volume control.</li> </ul>	—

## Connecting to a WPS network

Solution	Refer to Page
<p>If your wireless router support WPS (Wi-Fi Protected Setup™) your HEOS wireless speaker can optionally connect to your network using the “Push Button” method by following these steps:</p> <p>Wi-Fi Protected Setup™ is trademarks of Wi-Fi Alliance.</p> <ol style="list-style-type: none"> <li>1. Press the WPS button on your router.</li> <li>2. Within 2 minutes, press and hold the Connect button on the rear panel of the HEOS speaker for 3 seconds.</li> <li>3. The LED on the front of the speaker will flash green for several seconds as it connects to your WPS router.</li> <li>4. When the connection is complete, the LED on the front of the speaker will turn solid blue.</li> </ol>	7





## Resetting your speaker

Solution	Refer to Page
<p>Resetting your speaker will clear out the wireless network info, EQ, and name but retain it's current software. You will have to use Settings - Add Speaker to reconnect the speaker to your home network before it can be used.</p> <p>To reset your speaker, press and hold the Connect and Bluetooth buttons located on the back of the HEOS speaker for 5 seconds until the front LED begins to flash amber.</p>	-

## Restoring the speaker to factory defaults

Solution	Refer to Page
<p>Restoring the HEOS speaker to its factory defaults will clear all of the settings and restore the original software which was installed at the factory.</p> <p><b>Caution</b></p> <ul style="list-style-type: none"> <li>All settings will be erased and the software will likely be downgraded!</li> </ul> <p>To restore your HEOS speaker to the factory defaults, unplug the power cable from the back of the HEOS speaker. Press and hold the Bluetooth button located on the back of the HEOS speaker, reconnect the power cable, and hold it in until the front LED begins to flash amber.</p>	-

\* For further information, please visit <http://www.HEOSbyDenon.com>



## Contact Denon

**For U.S. & Canada only:**

If you need further assistance with your HEOS product, please contact HEOS by Denon Customer Support Services below:

Website: [www.HEOSbyDenon.com/Support](http://www.HEOSbyDenon.com/Support)

Email: [Support@HEOSbyDenon.com](mailto:Support@HEOSbyDenon.com)

Live Chat: [www.HEOSbyDenon.com/LiveChat](http://www.HEOSbyDenon.com/LiveChat)

Telephone: Toll Free (855) 499 2820

(M-F 10:00AM to 10:00PM EST / Sat 12:00PM to 8:00PM EST)









**For the other region:**

If you need additional help in solving problems, please contact Denon customer service in your area or visit <http://www.HEOSbyDenon.com>











## Status LED table









### [Example] HEOS 1

Device Operation	Description	Front LED Action	Rear LED Action
Off	No AC power or Deep Standby	 (off)	 (off)
Plug in	Booting	 (blink)	 (off)
On	Ready-Configured and connected to your network	 (solid)	 (off)
On	Not Connected to your network	 (solid)	 (solid)











Device Operation	Description	Front LED Action	Rear LED Action
Change Network	Connecting to your network	 (blink)	 (off)
Setup	Not connected	 (solid)	 (solid)
	Connect button was pressed	 (blink)	 (blink)
	Cable connection is OK	 (solid)	 (solid)











Device Operation	Description	Front LED Action	Rear LED Action
	Connecting to your network	 (blink)	 (off)
	Configured and connected to your network	 (solid)	 (off)
	Error	 (solid)	 (solid)
Update	Updating	 (blink)	 (blink)











Device Operation	Description	Front LED Action	Rear LED Action
	Rebooting	 (blink)	 (off)
	Ready-Configured and connected to your network	 (solid)	 (off)
Reset	Soft reset - Clear user settings	 (fast blink)	 (solid)
	Hard reset - Factory restore	 (blink)	 (solid)











Device Operation	Description	Front LED Action	Rear LED Action
	Rebooting	 (blink)	 (off)
	Ready-Not Configured	 (solid)	 (solid)
Errors	Firmware Error	 (slow blink (NOT fade))	 (off)
	Hardware Error	 (fast blink)	 (off)









Device Operation	Description	Front LED Action	Rear LED Action
	Network Error	 (solid)	 (solid)
Volume Change		 (quick blink)	 (off)
Mute		 (slow blink)	 (off)
WPS	a WPS session is active	 (fast blink)	 (fast blink)





Device Operation	Description	Front LED Action	Rear LED Action
	WPS connected	 (for 3 sec. solid)	 (solid)
	WPS time-out	 (for 3 sec. solid)	 (solid)
Power Management	Quick Start Mode	 (dimmed solid)	 (off)
	Deep Standby	 (off)	 (off)



Device Operation	Description	Front LED Action	Rear LED Action
Bluetooth	Bluetooth pairing is active	 (two blinks)	 (two blinks)
	Connected (No Network)	 (one blink)	 (off)
	Bluetooth pairing is failed	 (for 3sec. solid)	 (for 3sec. solid)



## Battery indicator of HEOS 1 Go Pack

The battery indicator uses 4 LEDs to indicate the approximate time remaining on the internal battery and the status of the charge process when connected to an AC power source.

### ■ When connected to the AC charger/power supply (charging)

Press and release the  $\Phi$  button to check the charging status. The charging indicator is displayed for approximately 5 seconds.

Mode	Battery Status	LED
Charging	100 %	
Charging	76 – 99 %	
Charging	51 – 75 %	
Charging	26 – 50 %	
Charging	0 – 25 %	

### ■ When running on battery power

Press and release the  $\Phi$  button to check the remaining battery. The remaining battery level is displayed for approximately 5 seconds.

Mode	Battery Status	LED
Battery Operation	76 – 100 %	
Battery Operation	51 – 75 %	
Battery Operation	26 – 50 %	
Battery Operation	6 – 25 %	
Battery Operation	0 – 5 %	



- Low Battery Indicator: When the battery level is near zero, the left LED may flash. This indicates that the AC charger needs to be connected as soon as possible.



## Supported file types and codecs

Frequency	Sample Rate	File Extension	Codec	Bit Rates
32/44.1/48 88.2/96/176.4 192 kHz	16/24 bit	wav	PCM	---
32 kHz 44.1 kHz 48 kHz	16 bit	mp3	MPEG-1 Audio Layer 3 CBR/VBR	32 - 320 kbps
32 kHz 44.1 kHz 48 kHz	16 bit	m4a aac	AAC-LC	48 - 320 kbps
32 kHz 44.1 kHz 48 kHz	16 bit	wma	wma9 CBR	CBR:48 - 192 kbps
44.1/48 88.2/96/176.4 192 kHz	16/24 bit	flac	flac	---
44.1/48 88.2/96/176.4 192 kHz	16/24 bit	m4a	ALAC	---

### NOTE

- Files protected by DRM such as Apple's Fairplay DRM, are not supported.
- If you select a music source with a high bit rate or high resolution, it is set to the appropriate level by codec before being output.
- The ALAC decoder is distributed under the Apache License, Version 2.0 (<http://www.apache.org/licenses/LICENSE-2.0>)



# Specifications

## Speaker specifications

### ■ HEOS 3

#### Wireless LAN

Network type:	Conforming to IEEE 802.11a/b/g/n/ac
Used frequency range:	2.4 GHz, 5 GHz

#### General

Operating temperature:	41 °F - 95 °F (5 °C - 35 °C)
Power supply:	AC 100 – 240 V, 50/60 Hz
Power consumption:	22 W
Power consumption in Quick Start Mode: *	3.9 W (Wi-Fi) 3.7 W (Ethernet) 4.3 W (USB) 3.9 W (Bluetooth)
Power consumption in Deep Standby Mode: *	0.3 W
Max Analog Input:	1 Vrms

\*Cable to AUX IN must be disconnected to enter Quick Start Mode and Deep Standby Mode.



## Dimensions

Unit : in. (mm)

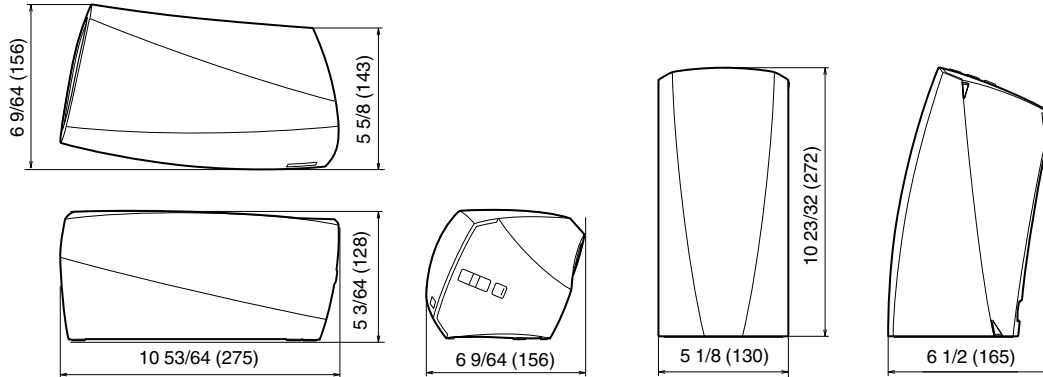

**Weight : 4 lbs 3 oz (1.9 kg)**

For the purpose of improvement, the specifications and design are subject to change without notice.



## ■ HEOS 1

### Wireless LAN

**Network type:** Conforming to IEEE 802.11a/b/g/n/ac

**Used frequency range:** 2.4 GHz, 5 GHz

### General

**Operating temperature:** 41 °F - 95 °F (5 °C - 35 °C)

**Power supply:** AC 100 – 240 V, 50/60 Hz

**Power consumption:** 20 W

**Power consumption in Quick Start Mode: \***  
4.1 W (Wi-Fi)  
3.5 W (Ethernet)  
4.5 W (USB)  
4.1 W (Bluetooth)

**Power consumption in Deep Standby Mode: \*** 0.3 W

**Max Analog Input:** 1 Vrms

\*Cable to AUX IN must be disconnected to enter Quick Start Mode and Deep Standby Mode.



## Dimensions

Unit : in. (mm)

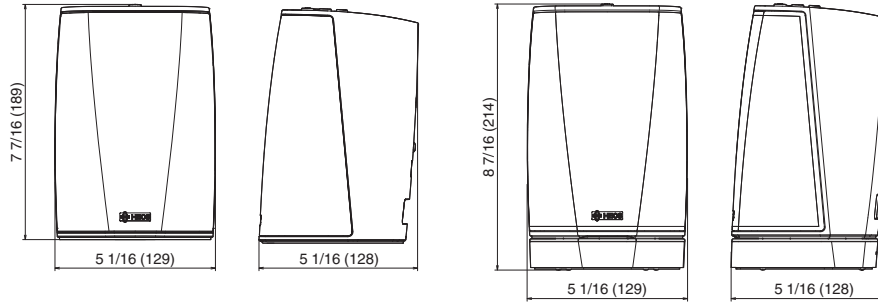

## Weight:

HEOS 1 : 3 lbs 1.4 oz (1.4 kg)

HEOS 1 + Go Pack : 3 lbs 12.0 oz (1.7 kg)

For the purpose of improvement, the specifications and design are subject to change without notice.





# Information

## Trademarks



Google Play and the Google Play logo are trademarks of Google LLC.



Apple, the Apple logo, iPad, iPhone, and iPod touch are trademarks of Apple Inc., registered in the U.S. and other countries. App Store is a service mark of Apple Inc.



Amazon, Kindle, Echo, Alexa, Dash, Fire and all related logos are trademarks of Amazon.com, Inc. or its affiliates.



The Bluetooth® word mark and logos are registered trademarks owned by Bluetooth SIG, Inc. and any use of such marks by D&M Holdings Inc. is under license. Other trademarks and trade names are those of their respective owners.



**DENON®**

[HEOSbyDenon.com](http://HEOSbyDenon.com)

3520 10467 00ADE

Copyright © 2016 D&M Holdings Inc. All Rights Reserved.