

Mythos Nine Loudspeakers

Thank You

Thank you for choosing the Definitive Technology Mythos Nine Loudspeaker System. Our engineers have spent many years in developing this product. In order to ensure that you experience the finest performance possible, we encourage you to take a moment to fully read this owner's manual and familiarize yourself with the proper installation and set-up procedures for your Mythos Nine speakers.



Definitive Technology[®]
The Leader in High-Performance Loudspeakers[®]

Specifications**Mythos Nine**

Dimensions:	28" long x 5.4" wide x 4.13" deep (711mm l x 137mm w x 105mm d) (speaker only, not including bracket)
Weight:	13 lbs. (6 kG)
Sensitivity:	90 dB
Frequency Response:	38 Hz – 30 kHz
Nominal Impedance:	8 ohms
Driver Complement:	Two each 4½" (11.4cm) BDSS High output drivers pressure coupled to two 4½" x 8" (11.4cm x 20.3cm) Low Bass Radiators, One 1" (25mm) ferro-magnetic fluid damped Pure Aluminum dome tweeter.

Specifications subject to change without notice.

Unpacking Your Mythos Nine Speakers

Please Inspect For Shipping Damage

Each loudspeaker leaves our plant in perfect condition. Any visible or concealed damage most likely occurred in handling after it left our plant and should be reported at once to your Definitive dealer or the delivery company that delivered your loudspeaker. Please unpack your system carefully. Save all cartons and packing materials in case you move or need to ship your system. Record the serial number found on the back of the Mythos Nine in the appropriate place on the product registration card, answer all questions and send it in.

VERY IMPORTANT: Accessories

Various parts and accessories that you will need to use your Mythos Nine are in the carton but are easy to overlook. Open both ends of the shipping carton. Carefully examine the contents of the shipping carton and packing material to find the plastic bags with accessories.

Positioning the Mythos Nine

The Mythos Nine may be used vertically as a L&R main or surround speaker or oriented horizontally and used as a center channel loudspeaker.

The Mythos Nine may be placed directly on top of TVs that have at least 5-inches (13 cm) of flat surface on top. Do not place the speaker on top of any surface that is not large or stable enough to securely support the speaker. If the speaker seems at all unstable or "tipsy" place the speaker somewhere else. The warranty does not cover damage caused by falls due to improper positioning of the speaker. If the speaker is above seated listener height, extend the leveling foot to point the speaker downward (See *Using the Leveling Foot* on page 3).

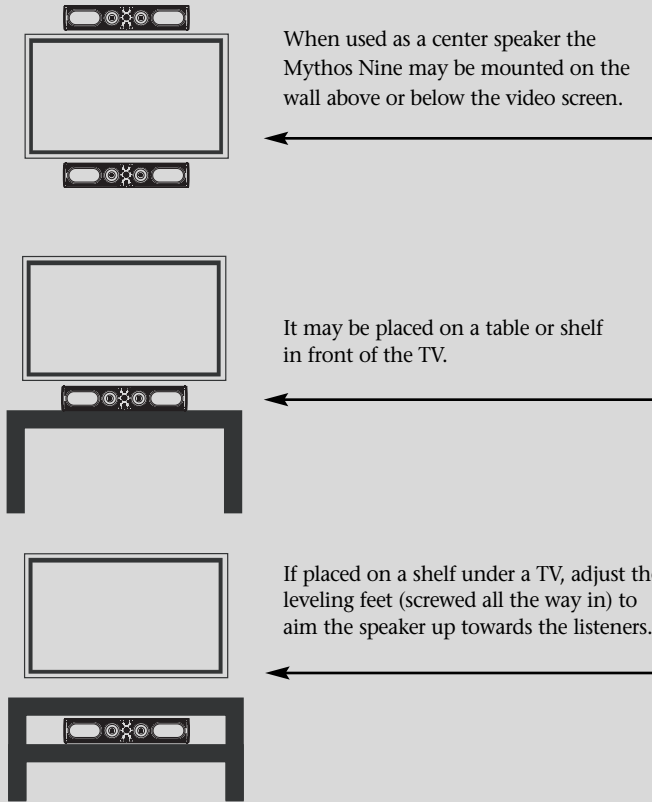

When used as L&R main or surround speaker the Nine must be wall-mounted flanking the screen as illustrated. Allow at least 3 inches (75 mm) between the edge of the video screen and the nearest edge of the speaker. If you need a speaker that can be shelf-mounted, please contact your Definitive Technology retailer. Definitive offers other models of Mythos Series speakers that have shelf-mount stands.

Even if you intend to place the Mythos Nine on a TV or shelf, you must attach the wall-mount bracket to the speaker. See *Using the Leveling Foot* on page 3.

Wall Mounting the Mythos Nine

- We recommend that wall mounting of speakers be performed by professional installers or by those appropriately skilled in the use of power tools and the knowledge of building codes and structural issues.
- We recommend that you determine a suitable location for your speaker installation, and that you complete all wiring (especially "hidden" in-wall wiring) before mounting brackets to your walls.
- Mythos Brackets are not suitable for ceiling mounting.

2. Make sure the location you have selected for wall-mounting does not conceal behind-wall electrical wiring or plumbing.
3. The supplied cardboard mounting template is double-sided; one side is for horizontal orientation and the other is for vertical mounting. Be sure to face the correct side toward you. Hold the cardboard template (included) in the intended location. Make sure the speaker clears the ceiling, adjacent walls, corners, beams, lighting fixtures and door/window frames. Leave at least 1 1/2" (38 mm) above or to the side of the speaker location to allow the speaker to slide onto the bracket.

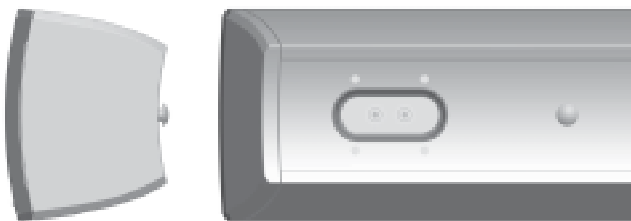

The Mythos Nine loudspeaker comes with a wall mounting bracket and template that makes secure mounting a breeze. Follow these directions for installing the wall mounting bracket.

1. Two 1/4"-20 screws have been factory installed on the back of the speaker. Gently hand-turn the screws to make sure they are in as far as they can go. Do not force them beyond the "stop" point. The screws cannot screw all the way into the speaker and should protrude as shown in the illustration.

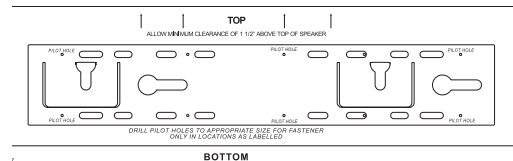

4. Make sure the center of the template is centered with the TV screen's center points.
5. When mounting the speaker horizontally use a bubble level to make sure the template is level. When mounting the speaker vertically, use a plumb line to find perfect vertical. If the TV is off-level or off plumb, the speaker will look better if it is off-level or plumb in exactly the same way as the TV.
6. Use push pins to secure the template to the wall.

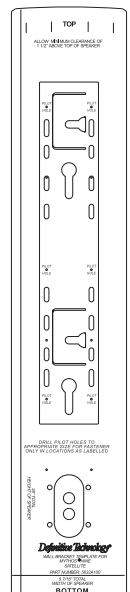

7. Mark the location of pilot holes noted on the Mounting Template with a pencil; remove the template.
8. Pre-drill the pilot-hole locations for mounting screws (not included). Use screws rated to hold securely in the wall material (we recommend #10 screws).
9. It is best if at least one screw hits a wall stud. If there is no stud behind the pilot hole location, install wall anchors (not included) to secure the bracket screws. Follow the wall anchor manufacturer's directions. Each wall anchor should be rated to hold at least one-half of the product net weight [see specifications on front cover].

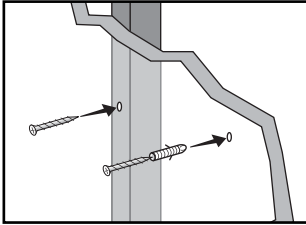

10. For masonry walls, use a masonry drill bit to pre-drill holes, and use masonry anchors and screws (not included).
11. Pull the speaker wires through the hole in the bracket.
12. Screw the bracket to the wall.
13. The bracket has two sets of keyhole slots, one set for vertical and the other set for horizontal orientation. When the wall mounting bracket is securely screwed to the wall, line up the speaker's protruding Mounting Screws with the appropriate keyhole slots on the wall mounting bracket. Let the speaker slide straight down (in horizontal alignment) or push the speaker sideways (vertical alignment), allowing the screw heads to slip behind the smaller end of the keyhole slots. Gently push the edge of the speaker opposite the screw heads toward the wall until the speaker snaps onto the lower lip of the bracket.

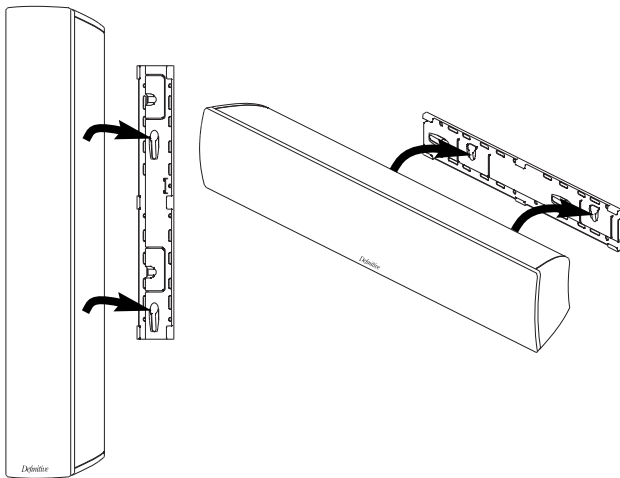

Mounting the Mythos Nine to an articulating TV bracket

If you have a Plasma or LCD TV that is attached to the wall via a swing-out articulating bracket such as those offered by Chief, Sanus and OmniMount, the Mythos Nine speaker may be attached to the bracket without using the supplied wall-mount plate. Simply use 1/4"-20 screws to attach the speakers directly to the TV bracket. Consult the TV bracket manufacturer's user manual for more specific speaker mounting instructions.

MYTHOS NINE

Using the Leveling Foot

If you are going to use the Mythos Nine in horizontal mode on a shelf or table, first attach the wall bracket to the speaker as described above. Attach the one "L" bracket to the wall bracket using one M4 x 10mm screw provided. Thread the foot screw into "L" bracket and adjust to required height.

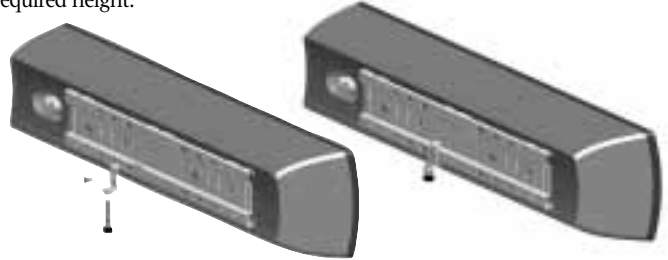

Attaching the Logo Badge

Mythos Nine can be mounted either vertically as main or surround speakers, or horizontally for use as a center channel speaker. The logo badge is not pre-attached to the grille and is packaged in a plastic bag along with the other accessories, and should be affixed in the correct place on the grille once you have determined the speaker's alignment. For horizontal (center channel) use, align the badge with the location on the long side of the grille (see illustration); for vertical use, align the badge with the location on the short side of the grille. To affix the logo badge, hold the grille in your hands as shown in the illustration. Using your thumbs, carefully press the badge posts through the cloth and into the two badge slot holes. The logo badge should snap into place. Do not press the badge too hard or you may crack the grille.

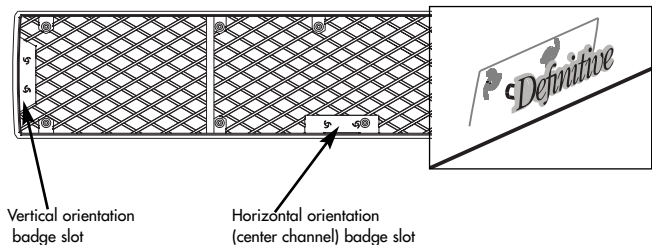

Connecting the Mythos Nine

To connect the speaker to your receiver or amplifier, strip 1/2 inch (15 mm) of insulation from each conductor of the speaker wire to expose the bare metal and twist each of the individual conductors into single un-frayed strands.

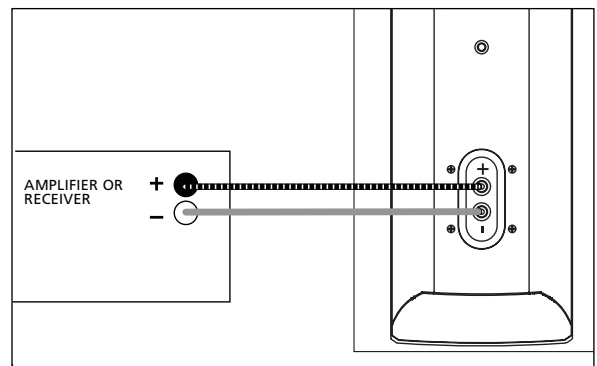

Definitive Technology Offices
 11433 Cronridge Drive, Owings Mills, Maryland 21117
 Phone: (800) 228-7148 (US & Canada),
 01 (410) 363-7148 (all other countries)

Note that one of the terminals is marked with red band (+) and the other is marked with black band (-). Make certain that you connect the wire from the red (+) terminal of your amplifier or receiver to the red (+) terminal on your speaker and the wire from the black (-) terminal of your amplifier or receiver to the black (-) terminal on your speaker. Most speaker wire has some indicator (such as color-coding, ribbing or writing) on one of the two conductors to help you maintain consistency. It is essential to connect both speakers to the amplifier in the same way (in phase). If you experience a lack of bass or poor surround effect, it is likely that one or more of the channels is connected in incorrect polarity and needs to be rewired, paying closer attention to connect positive to positive; negative to negative on all channels.

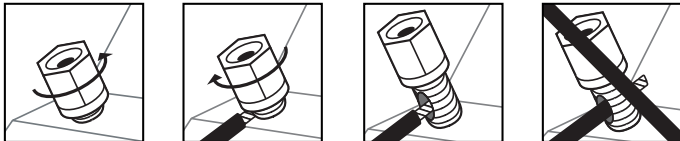

To connect wire to the binding post [see figure above], unscrew the knurled nut and insert the bare wire into the hole near the base of the binding post. Do not insert the insulated part of the wire into the hole as this will not give you a good connection. Twist the hex nut back down the binding post until it firmly meets the wire. Do not over-tighten.

Connect a single RCA cable from the "SUB OUT" of your receiver to the LFE input of the subwoofer (not included). This connecting method bypasses the subwoofer's internal "crossover" or low pass filter and relies on the crossover filter built into your receiver.

Receiver/Speaker Set-up

Access Your Receiver's "Speaker Set-up" or "Speaker Configuration" Menu



1. In the Speaker Set-up/Configure function of your receiver, set all channels that are connected to Mythos Nines to "Small."

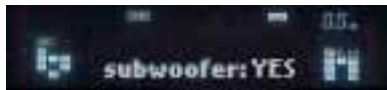

2. Select "Yes" when asked if you are using a subwoofer.
3. Set the subwoofer crossover frequency on the receiver to 100 Hz.

Service

Service and warranty work on your Definitive loudspeakers will normally be performed by your local Definitive Technology dealer. If, however, you wish to return the speaker to us, please contact us first, describing the problem and requesting authorization as well as the location of the nearest factory service center. Please note that the address given in this booklet is the address of our offices only. Under no circumstances should loudspeakers be shipped to our offices or returned without contacting us first and obtaining return authorization.

Technical Assistance

It is our pleasure to offer assistance if you have any questions regarding your Mythos Nine or its set-up. Please contact your nearest Definitive Technology dealer or call us directly at (800) 228-7148 (US & Canada), 01 (410) 363-7148 (all other countries) or e-mail info@definitivetech.com.

Limited Warranty: 5-Years for Drivers and Cabinets, 3-Years for Electronic Components

Definitive Technology warrants to the original retail purchaser only that this Definitive Technology Loudspeaker Product (the "Product") will be free from defects in materials and workmanship for a period of five (5) years covering the drivers and cabinets, and three (3) years for the electronic components from the date of the original purchase from a Definitive Technology Authorized Dealer. However, this warranty will automatically terminate prior to the expiration of five (5) years for the drivers and cabinets and three (3) years for the electronic components if the original retail purchaser sells or otherwise transfers the Product to any other party. The original retail purchaser shall hereinafter be referred to as "you." Defective Products must be shipped, together with proof of date of purchase, prepaid insured to the Authorized Dealer from whom you purchased the Product, or to the nearest factory service center. Product(s) must be shipped in the original shipping container or its equivalent; in any case the risk of loss or damage in transit is to be borne by you. If, upon examination at the Factory or a Definitive Technology Authorized Dealer, it is determined that the unit was defective in materials or workmanship at any time during this Warranty period, Definitive Technology or the Definitive Technology Authorized Dealer will, at its option, repair or replace this Product at no additional charge, except as set forth below. All replaced parts and Product(s) become the property of Definitive Technology. Product(s) replaced or repaired under this Warranty will be returned to you, within a reasonable time, freight collect.

This Warranty does not include service or parts to repair damage caused by accident, misuse, abuse, negligence, inadequate packing or shipping procedures, commercial use, voltage in excess of the rated maximum of the unit, cosmetic appearance of cabinetry not directly attributable to defects in materials or workmanship, or service, or repair or modification of the Product which has not been authorized by Definitive Technology. Definitive Technology makes no Warranty with respect to its Products purchased from dealers or outlets other than Definitive Technology Authorized Dealers. This Warranty is in lieu of all other expressed Warranties. If this Product is defective in material or workmanship as warranted above, your sole remedy shall be repair or replacement as provided above. In no event will Definitive Technology be liable to you for any incidental or consequential damages arising out of the use or inability to use the Product, even if Definitive Technology or a Definitive Technology Authorized Dealer has been advised of the possibility of such damages, or for any claim by any other party. Some states do not allow the exclusion or limitation of consequential damages, so the above limitation may not apply to you.

All implied warranties on the Product are limited to the duration of this expressed Warranty. Some states do not allow limitation on how long an implied Warranty lasts, so the above limitations may not apply to you. This Warranty gives you specific legal rights, and you also may have other rights which vary from state to state.



This product complies with the essential requirements of the EMC directive 89/336/EEC.