

Linea Research
44C/88C Series Advanced System Amplifier
User Guide

Version 6 (For firmware version 1.478 and above)



Contents

IMPORTANT SAFETY INSTRUCTIONS	5
CONSIGNES DE SÉCURITÉ IMPORTANTES.....	6
COMPLIANCE	7
FOR CUSTOMERS IN EUROPE	7
FOR CUSTOMERS IN THE USA.....	8
FOR CUSTOMERS IN THE CANADA	8
Thanks and Unpacking.....	9
Unpacking the Linea Research 44/88 C Series Amplifier.....	9
INSTALLATION INSTRUCTIONS	10
Mechanical Installation	10
AC Power Connection.....	11
Introduction and Key Features	12
Introduction.....	12
Key Features	12
Audio Connections.....	15
Input Connections	15
Using unbalanced connections.....	15
Amplifier Output Connections.....	16
Load Matching.....	17
Panel Layouts.....	18
Operation.....	20
Starting up the unit.....	20
Overview of Modules, Presets Components and Snapshots.....	20
Drive Module Presets	21
Component Presets	22
Factory Module Presets.....	22
Storing Module Presets	22
Recalling Module Presets	22
Recalling Components	22
Input	23
AES3 Inputs.....	23
Networked Audio (Dante) Inputs	23
Automatic Input Selection (Fallover).....	23
Gain and Polarity	23

Delay	24
High Pass Filter	24
Parametric Equalisation.....	24
FIR Shelving EQ.....	24
Parametric Filters	24
Routing.....	25
Output	25
Gain and Polarity	25
Delay.....	25
High and Low pass Filters	25
LIR Crossover Filtering	25
Parametric Equalisation and All-Pass Filters	26
FIR Filter (available on some models).....	26
Limiters	26
Bridge.....	27
Routing.....	27
Dante Outputs	27
Stereo Linking	28
IP Address	28
Store Snapshot.....	28
ECO	29
External Breaker Protection (EBP).....	29
Ethernet.....	29
Ethernet configurations.....	29
DHCP	29
AUTO-IP	29
Static-IP.....	30
IP Troubleshooting.....	30
Snapshots	30
AUX Port A	30
Fault Relay A	31
AUX Port B	31
Check Relay B.....	31
AUX Port C	31
RS232/ RS485	31

Latency delay	32
Input/Output Latencies	32
Processing Latencies	32
Overlay Flush	33
Revert to Factory Settings	33
Protection Systems	33
Summary of Protection Indication	33
Incident Reporting	34
Performance Logging	34
Tipi Third Party Interface	35
Processing Block Diagram	36
EQ and Filter Response Graphs	37
Technical Specifications	40
General	40
Audio	40
Digital processing	40
Power Output	41
Power supply	41
Protection systems	41
System protection	42
Power distribution protection systems	42
Monitoring and logging	42
OEM Features	42
Physical	42
Options	43

IMPORTANT SAFETY INSTRUCTIONS



The lightning bolt triangle is used to alert the user to the risk of electric shock.



The exclamation point triangle is used to alert the user to important operating or maintenance instructions.

- 1 Read these instructions.
- 2 Keep these instructions.
- 3 Heed all warnings.
- 4 Follow all instructions.
- 5 Do not use this apparatus near water.
- 6 Clean only with dry cloth.
- 7 Do not block any ventilation openings. Install in accordance with the manufacturer's instructions.
- 8 Do not install near any heat sources such as radiators, heat registers, stoves or other apparatus (including amplifiers) that produce heat.
- 9 Do not defeat the safety purpose of the polarized or grounding type plug. A polarized plug has two blades with one wider than the other. A grounding type plug has two blades and a third grounding prong. The wide blade or the third prong are provided for your safety. If the provided plug does not fit into your outlet, consult an electrician for replacement of the obsolete outlet.
- 10 Protect the power cord from being walked on or pinched particularly at plugs, convenience receptacles and the point where they exit from the apparatus.
- 11 Only use attachments / accessories specified by the manufacturer.
- 12 Use only with the cart, tripod, bracket or table specified by the manufacturer, or sold with the apparatus. When a cart is used, use caution when moving the cart / apparatus combination to avoid injury from tip-over.
- 13 Unplug this apparatus during lightning storms or when unused for long periods of time.
- 14 Refer all servicing to qualified service personnel. Service is required when the apparatus has been damaged in any way, such as power-supply cord or plug damaged, liquid has been spilled or objects have fallen into the apparatus, this apparatus has been exposed to rain or moisture, does not operate normally, or has been dropped.
- 15 The apparatus shall not be exposed to dripping or splashing and no objects filled with liquids, such as vases, shall be placed on the apparatus.
- 16 Permanent disconnection from the mains supply is to be achieved by removing the supplied cord connector from the back of the unit. This connector must remain readily operable.



WARNING

Do not remove any covers, loosen any fixings or allow items to enter any aperture.



WARNING

This product must be earthed. Use only a flexible cable or cord with a green and yellow core which must be connected to the protective earthing terminal of a suitable mains plug or the earthing terminal of the installation



WARNING

The rear of the product may get hot. Avoid direct skin contact during operation and for at least 5 minutes after power has been isolated.



WARNING

This product is designed for permanent installation. It must be fitted in to a 19" rack enclosure and not operated unless so installed. The rack enclosure must allow free air movement through the product.

CONSIGNES DE SÉCURITÉ IMPORTANTES



Le triangle de l'éclair est utilisé pour alerter l'utilisateur
À risque d'électrocution.



Le triangle du point d'exclamation est utilisé pour alerter l'utilisateur sur des importants
Instructions d'utilisation ou d'entretien.

1. Lisez ces instructions.
2. Conservez ces instructions.
3. Respectez tous les avertissements.
4. Suivez toutes les instructions.
5. Ne pas utiliser cet appareil près de l'eau.
6. Nettoyer uniquement avec un chiffon sec.
7. Ne pas bloquer les ouvertures de ventilation. Installer conformément aux instructions du fabricant.
8. Ne pas installer près de sources de chaleur telles que radiateurs, registres de chaleur, poêles ou autres appareils (y compris les amplificateurs) qui produisent de la chaleur.
9. Ne supprimez pas le dispositif de sécurité de la fiche polarisée ou mise à la terre. Une fiche polarisée possède deux lames dont l'une est plus large que l'autre. Une prise de terre a eu deux lames et une troisième broche de terre. La lame large ou la troisième broche sont fournies pour votre sécurité. Si la fiche fournie ne rentre pas dans votre prise, consultez un électricien pour remplacer la prise obsolète.
10. Protéger le cordon d'alimentation soit écrasé ou pincé, particulièrement au niveau des fiches, des prises et le point où ils sortent de l'appareil.
11. Utilisez uniquement les accessoires spécifiés par le fabricant.
12. Utilisez uniquement le chariot, le trépied, le support ou la table spécifiés par le fabricant, ou vendu avec l'appareil. Quand un chariot est utilisé, soyez prudent lorsque vous déplacez l'ensemble chariot / appareil afin d'éviter toute blessure en cas de chute.
13. Débranchez cet appareil pendant les orages ou lorsqu'il n'est pas utilisé pendant de longues périodes de temps.
14. Adressez-vous à un personnel qualifié. Une réparation est requise lorsque l'appareil a été endommagé de quelque façon que ce soit le cordon d'alimentation ou la fiche endommagé, du liquide a été renversé ou des objets sont tombés dans l'appareil, cet appareil a été exposé à la pluie ou à l'humidité, ne fonctionne pas normalement, ou s'il est tombé.
15. Le dispositif ne doit pas être exposé à des gouttes ou des éclaboussures et aucun objet rempli de liquides, tels que des vases, doit être placé sur l'appareil.
16. Déconnexion permanente de l'alimentation secteur doit être atteint en supprimant le connecteur du cordon fourni à l'arrière de l'unité. Ce connecteur doit être facilement utilisable.



ATTENTION

Ne retirez pas les couvercles, ne desserrez pas les fixations et ne laissez aucune pièce s'introduire dans les ouvertures.



ATTENTION

Ce produit doit être mis à la terre. Utilisez uniquement un câble souple avec un noyau vert ou vert / jaune qui doit être relié à la borne de terre de connecteur d'alimentation ou la borne de terre de l'installation.



ATTENTION

Le radiateur arrière de cet appareil devient chaud. Evitez tout contact direct avec la peau pendant le fonctionnement et au moins 5 minutes après la mise hors tension de l'appareil.



ATTENTION

Ce produit est conçu pour une installation permanente. Il doit être installé dans un boîtier rack 19 ". L'enceinte du rack doit permettre un mouvement de l'air libre à travers le produit.

COMPLIANCE

FOR CUSTOMERS IN EUROPE

This product complies with both the LVD (electrical safety) 2014/35/EU and EMC (electromagnetic compatibility) 2014/30/EU directives issued by the commission of the European Union.

Compliance with these directives is demonstrated by conformity with the following European standards:

EN60065 8th Edition	Electrical safety
EN55032-2012	EMC emissions
EN55035-2017	EMC immunity



ATTENTION

This equipment is compliant with Class A of CISPR 32. In a residential environment this equipment may cause radio interference in which case the user may be required to take separate measures.



THIS PRODUCT MUST BE EARTHED. Use only a flexible cable or cord with a green and yellow core which must be connected to the protective earthing terminal of a suitable mains plug or the earthing terminal of the installation. The cord must be a maximum of 2m long, have a 4.0mm² CSA, a 300/500V rating and comply with EN50525-2-11 / H05W-F (105°C).

FOR CUSTOMERS IN THE USA

This product complies with UL60065 8th edition.



THIS PRODUCT MUST BE EARTHED. Use only a flexible cable or cord with a green or green / yellow core which must be connected to the protective earthing terminal of a suitable mains plug or the earthing terminal of the installation. The cord must be a maximum of 6' long, be 12AWG, 105°C have a rating SJ, SJT, SJE or 300/500V H05W-F and be marked VW-1.



ATTENTION

FCC SUPPLIER'S DECLARATION OF CONFORMITY (SDoC) : We, Linea Research Ltd. of 1 Marquis Business Centre, Royston Road, Baldock, Hertfordshire, SG7 6XL, England, represented in the United States by Allied Professional Technologies, LLC - www.alliedprotech.com , declare under our sole responsibility that the M-Series and C-Series families of products comply with Part 15 of the FCC Rules. Products covered by this declaration have model numbers of the form xxMxx or xxCxx where 'x' may be any number between 1 and 9.

FCC NOTE : An example of this equipment has been tested and found to comply with the limits for a Class A digital device, pursuant to part 15 subpart B of the FCC Rules. These limits are designed to provide reasonable protection against harmful interference when the equipment is operated in a commercial environment. This equipment generates, uses, and can radiate radio frequency energy and, if not installed and used in accordance with the instruction manual, may cause harmful interference to radio communications. Operation of this equipment in a residential area is likely to cause harmful interference in which case the user will be required to correct the interference at his own expense.

FCC CAUTION: Any changes or modifications not expressly approved by the party responsible for compliance could void the user's authority to operate this equipment.

FOR CUSTOMERS IN THE CANADA

This product complies with CA /CSA C22.2 No.60065-03
Ce produit est conforme avec CA /CSA C22.2 No.60065-03

DECLARATION OF CONFORMITY WITH CANADIAN ICES-003

This Class A digital apparatus complies with Canadian ICES-003.

Cet appareil numérique de la classe A est conforme à la norme NMB-003 du Canada.



THIS PRODUCT MUST BE EARTHED. Use only a flexible cable or cord with a green or green / yellow core which must be connected to the protective earthing terminal of a suitable mains plug or the earthing terminal of the installation. The cord must be a maximum of 6' long, be 12AWG, 105°C have a rating SJ, SJT, SJE or 300/500V H05W-F and be marked VW-1.



CE PRODUIT DOIT ÊTRE MIS À LA TERRE. Utilisez uniquement un câble souple avec un noyau vert ou vert / jaune qui doit être relié à la borne de terre de connecteur d'alimentation ou la borne de terre de l'installation. Le cordon doit être un maximum de 6' (2m) de long, 12 AWG (4.0mm² CSA), 105°C être classé SJ, SJT, SJE ou 300/500V H05W-F et être marquée VW-1

Thanks and Unpacking

Thank you for choosing a Linea Research 44/88 C Series Advanced System Amplifier for your application. Please spare a little time to study the contents of this manual, so that you obtain the best possible performance from this unit.

All Linea Research products are carefully engineered for world-class performance and reliability.

If you would like further information about this or any other Linea Research product, please contact us. We look forward to helping you in the near future.

Unpacking the Linea Research 44/88 C Series Amplifier

After unpacking the unit please check carefully for damage. If damage is found, please notify the carrier concerned at once. You, the consignee, must instigate any claim. Please retain all packaging in case of future re-shipment.

INSTALLATION INSTRUCTIONS

Mechanical Installation

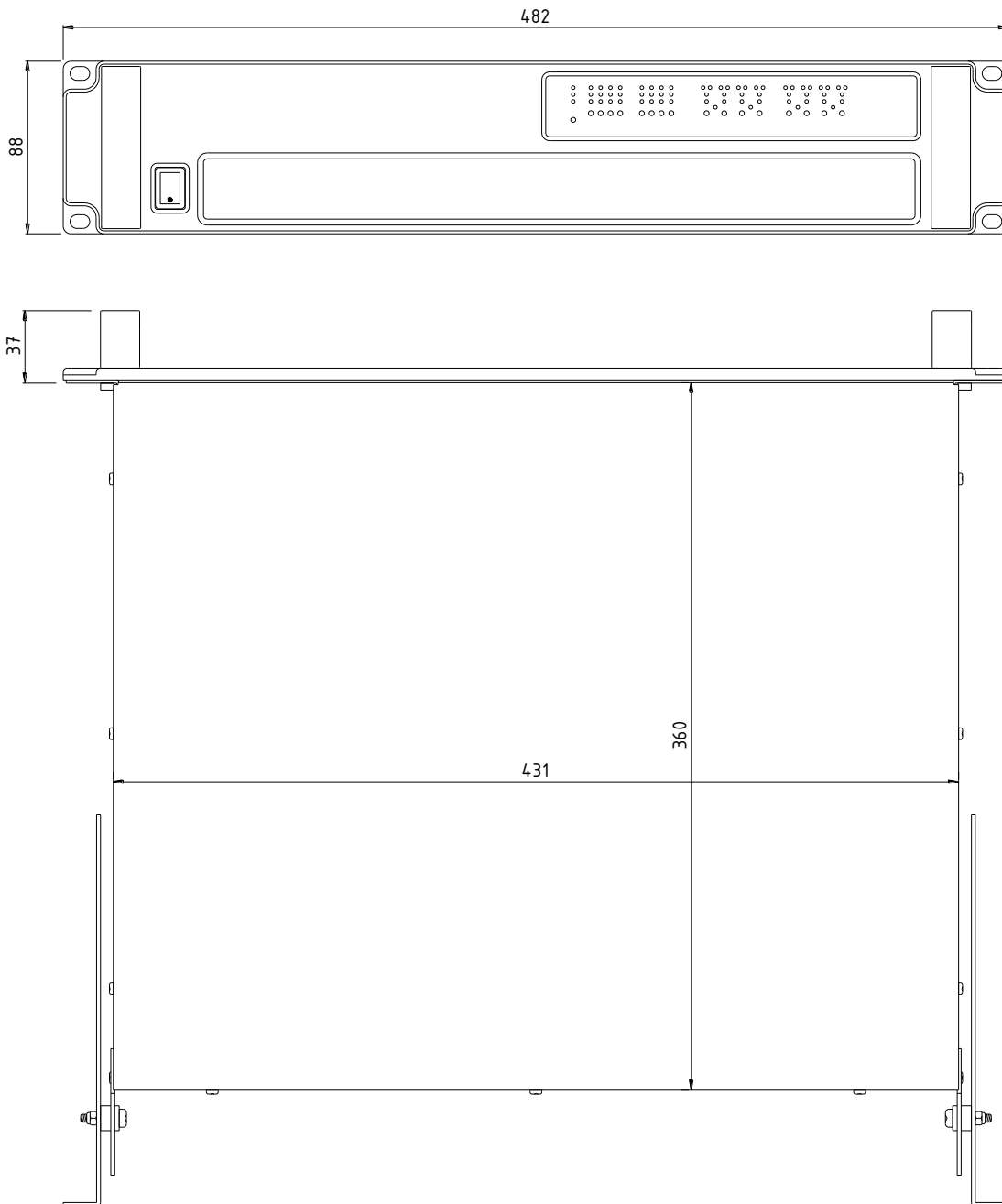

 The 44/48 Series Amplifier must only be operated when mounted in a standard 19" rack enclosure.

Where the amplifier is used in a fixed installation, as long as the bottom unit is supported and there are no gaps between units, it is acceptable to use only the front panel 19" rack mounting points when fitting it in a standard rack enclosure. If the amplifier is mounted in a mobile rack it is important that the rear is supported

with a rear rack mounting kit (part number ZA1182). Damage caused by insufficient support is not covered by the manufacturer's warranty.

To prevent damage to the front panel it is recommended that plastic cups or washers are fitted underneath the rack mounting bolt heads.

It is possible to mount multiple 44/48 Series amplifiers without ventilation gaps between them but it is essential that an unobstructed flow of clean air is available from the front of the unit to the rear.



IMPORTANT

General

The amplifier should never be exposed to rain or moisture during operation or storage. If the unit does come into contact with moisture, remove the AC power cord immediately and leave it in a dry and warm location.

Note that when any equipment is taken from a cold location into a warm humid one, condensation may occur inside the device. Always allow time for the equipment to attain the same temperature as its surrounding environment before connecting the AC power cord.

It is the responsibility of the user to ensure that dirt, liquids and vapour from theatrical smoke and fog machines is not ingested by the amplifier. Damage so caused is not covered by the manufacturer's warranty.

Cooling

It is important that neither the air intakes on the front of the unit or the exhaust vents at the rear are obstructed. Steps must also be taken to ensure that hot air does not continually circulate through the amplifiers from the back of the rack to the front.

The air intake filter must be cleaned regularly with warm water and a little detergent to ensure unrestricted airflow. The filter can be removed without the use of tools by gently pulling it out of its aperture. When refitting ensure that it is thoroughly dry and that there are no areas of the grille not covered by the filter element. Operating the amplifier without the air intake filter will invalidate the manufacturer's warranty.

AC Power Connection

The amplifier utilises a 32A Neutrik PowerCon™ type locking AC power connector. Use only an AC power cord correctly terminated with a genuine Neutrik™ PowerCon™. It is the responsibility of the user to ensure that all wiring is performed by a qualified person in accordance with all local regulations.

The amplifiers are designed to operate on 115V 60Hz or 230V 50 Hz nominal AC power, automatically configuring themselves at switch on. Note that although the amplifiers will operate when the mains supply is within the range specified in this document, various specifications will only be met when the unit is operated at the stated nominal voltages.

Introduction and Key Features

Introduction

The Linea Research 44/88 C Series Advanced System Amplifier represents current state-of-the-art technology in several areas. This product is the result of several years of research, from which many advances in switched mode power technologies and ever finer detail in signal processing have stemmed. Taking advantage of the latest advances in analogue to digital conversion technologies, the unit achieves performance levels among the very best that engineering permits.

Below is a list of key features, followed by some information on the major advanced features of the product.

Key Features

- Four/Eight channels of sonically pure Class D amplification
- Very high power density - packs four channels and 20kW or eight channels and 10kW into just 2U of rack space
- Packed with robust protection and monitoring systems to keep the show going
- External Breaker Protection (EBP) limits the current draw to prevent breakers opening
- Linea Research minimal signal path design
- Class leading sonic performance achieved by the use of state of the art Amplifier technologies and highly advanced DSP algorithms using Linea Micro Detail (LMD)
- 96kHz sampling frequency provides for a nominally flat response beyond 40kHz.
- Simple tamper-proof front panel offers intuitive indication of status
- High speed Ethernet communications supporting DHCP, static-IP and auto-IP and direct connection to a computer without the need for a router or a switch
- Powerful Drive Module concept, abstraction from device centric to speaker based control
- Innovative Component Presets to allow individual outputs to be used for selected drivers of a loudspeaker system
- Twelve layers of Parameter Overlays for trouble-free Grouping
- Unique VX limiter providing dynamic control for passive 2-way enclosures
- Unique LIR linear phase crossover shapes giving FIR-like performance with minimal latency and without requiring a design
- Linear phase HF system EQ profiling which provides perfect integration between enclosures
- Transducer thermal modelling provides regulation limiters, addressing long term overload
- Overshoot limiter governs amplitude of transient signals retaining average power whilst constraining peak energy
- (Optional) Dante audio networking input with automatic fall over to Analogue or AES3. AES67 mode available
- (Optional) Dante audio networking output which may be routed from various positions
- AES3 input

Drive Modules

The 44/88 C Series processor has a new way of ordering and grouping channels in order to give a more speaker-based approach to controlling, designing and recalling speaker configurations; these are called Drive Modules. A Drive Module is the Processing provided by one Input DSP Block, and a number of Output DSP Blocks, which are associated with one-another by means of routing. For example, if Input DSP Block B is routed to Outputs 3 and 4, then this is a 2-way Drive Module with Input DSP Block B forming the 'Master' control, and Output DSP Blocks 3 and 4 providing the driver-related control. Overall, this forms the processing typically for one loudspeaker sub-system. The System Engineer Drive Module control panel for this sub-system may then be used for control and monitoring of the associated speaker.

Drive Modules may be included in Module Groups, which use the Parameter Overlay feature in the Device to achieve trouble-free Grouping in the System Engineer application.

The Presets in the Device are Drive-Module centric, and are used to configure individual Drive Modules rather than the whole device.

Importantly, Drive Modules move the focus away from the processing device, and onto the loudspeaker systems.

A Drive Module Preset may be broken apart into Components, allowing any output to be used for any component within a Drive Module Preset (i.e. any driver in a loudspeaker subsystem).

See [Overview of Modules](#)

Overlays

When the Device is used in Modules view in System Engineer, this allows the modules to be grouped into *Overlay Groups*. These groups allow various Input (master) parameters to be adjusted in *all modules* in that group, whilst maintaining independent parameter values across each group. This is achieved in the device by combining the parameters for all the layers for a given section (Gain Delay, EQ etc.). When an Overlay parameter is active, the Overlay indicator will become illuminated. The combined Gain or Delay etc. associated with a given section is shown on the module panel in System Engineer, within square brackets [] under the Delay and Gain for each input channel. The combined EQ curve is shown in an olive colour. The Input Mute button in System Engineer will flash if an overlay mute is active. An input overlay mute is indicated on the mute/clip indicator for that channel flashing. See [Overlay Flush](#). Note that overlays are not stored in presets or snapshots or carried in settings files.

LIR Linear Phase Crossover Filtering

The Device also includes a new type of crossover filtering "Linear Impulse Response" (LIR) crossover filtering, which results in a Linear Phase crossover that has a constant delay regardless of frequency (unlike other types of crossover which delay different frequencies to a different extent, thus smearing the arrival time). The LIR crossover can thus be described as having a flat Group Delay response, and thus entirely free of Group Delay Distortion.

The shape of the LIR crossover filter is quite similar to a 4th order or 24dB/Oct Linkwitz-Riley filter, and maintains zero phase difference between the adjacent bands across the crossover region to keep the polar response rock steady.

FIR Linear Phase Equalisation

The Input High-Shelf Equalisers use Finite Impulse Response (FIR) filtering to produce Linear Phase equalisation; that is all frequencies are delayed by the same amount, perfectly preserving the transient

response. This can also be important in applications where different amounts of EQ are applied to different parts of a speaker cluster, such as to add 'Throw' EQ boost so that parts of cluster which are throwing further can have HF absorption correction added. If this EQ is not linear phase, then the zones where the speakers combine may suffer frequency response anomalies.

FIR Output Processing (available on some models)

Each output has a Finite Impulse Response (FIR) filter which may be programmed using a 3rd party application for further Equalisation and phase correction. Such FIRs may be designed for Linear Phase response, either for equalisation or from linear phase crossovers.

Audio Connections

Input Connections

For each input channel there are 3 pins of a Phoenix connector for analogue inputs.

There is also a 6 pin Phoenix connector for one stream (two channels) of AES3 digital audio. The three terminals marked 'In' should be used as the AES3 input to the device. The 'Link' terminals are intended to feed a buffered version of the input on to another device. The 'Link' output will still work even when power is not applied to the device. Note that only two channels of AES3 digital audio are available. The Dante option permits more channels of Digital Audio inputs.

The HOT, + or 'in phase' connection should be made to the + pin of the Phoenix connector.

The COLD, - or 'out of phase' connection should be made to the - pin of the Phoenix connector.

The '⏏' Pin of the input connectors is internally connected to the chassis. The shield of the input cable should always be connected to the '⏏' Pin of the input connector to ensure that EMC performance and regulations are met.

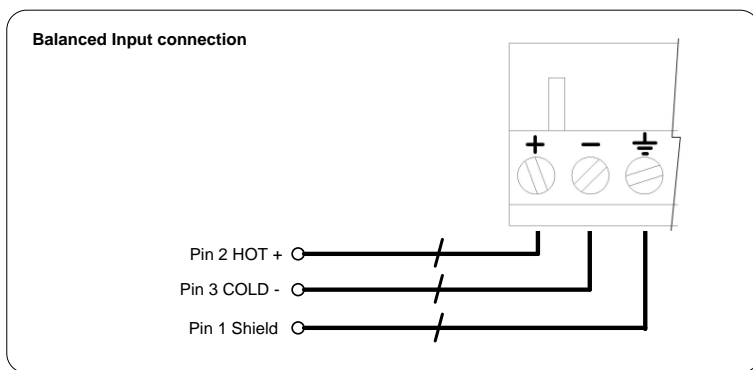

Using unbalanced connections

Please note that the use of unbalanced connections is not recommended, however when connecting the amplifier to an unbalanced audio source, the signal conductor should be connected to the '+' terminal. The 'Cold' conductor or cable screen should be connected to the '-' terminal with a short connection made between the '-' pin and the '⏏' pin.

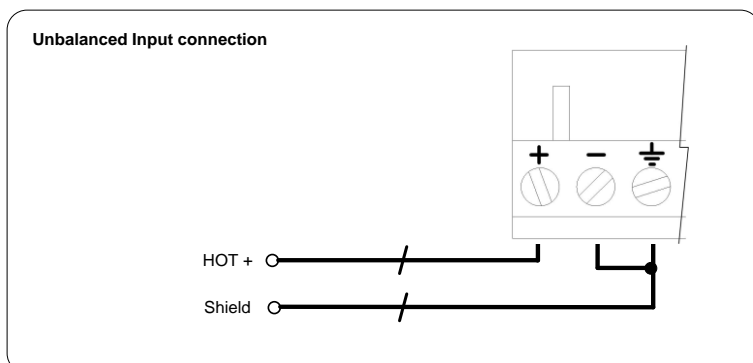

Amplifier Output Connections

 Note : The 44C and 88C series amplifier can produce high voltages at their outputs. Always use genuine Neutrik Speakon™ connectors. Un-bridged outputs must use Class 2 or class 3 wiring. Bridged channel pairs must use Class 3 wiring. Custom wiring must only be performed by qualified personnel.

The 44C amplifier is fitted with one Speakon™ connector per amplifier channel. The appropriate conductor terminations are shown below and on the rear panel of the unit.

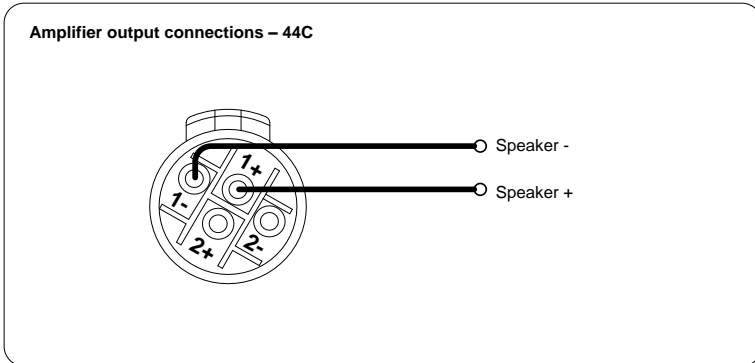

Additionally, the channel 2 output is duplicated on the Speakon™ connector for amplifier channel 1 for Bi-Amp wiring. Similarly, the channel 4 output is duplicated on the Speakon™ connector for amplifier channel 3. This can be useful for making a connection to two loudspeakers with one 4-core cable (i.e. Bi-Amp).

On the 88C model, all outputs are Bi-Amp; each Speakon™ connector carries two amplifier outputs – Channels 1&2, Channels 3&4, Channels 5&6 and Channels 7&8.

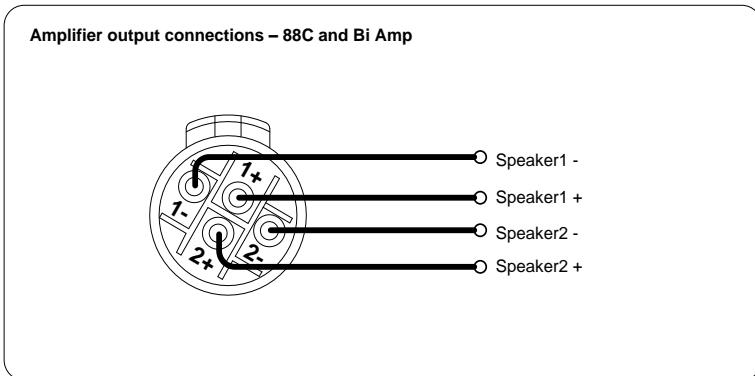

In addition, the channel 1 or channel 3 connector (all the Speakon™ connectors on the 88C model) can also be used if the pair of amplifier channels is being operated in bridged mode.

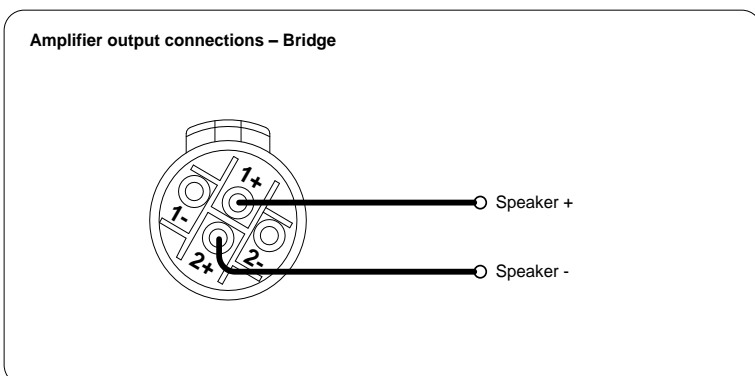

More than one speaker can be connected to each channel provided the total impedance per channel is not less than **2 ohms**. In bridged mode the minimum total impedance should not be less than **4 ohms**.

Also see [Dante Outputs](#).

Load Matching

Each output of the device can be optimised to drive either a low impedance load (e.g. 2, 4 or 8 Ohms), or a Constant Voltage (C.V.) using the Load parameter in the Output menu. There are several C.V. settings (25V, 70V and 100V Line) which determine the maximum RMS voltage that the amplifier will produce. Select the one which is appropriate for the installation. A number of low impedance settings (depending on the model) are also available. Although it is not critical that this setting matches the impedance of the connected load, this will maximise the power that is available for the load. An 'Auto' setting is also available, which optimises the maximum voltage/current available to maximise the output power for a given measured load impedance.

Panel Layouts

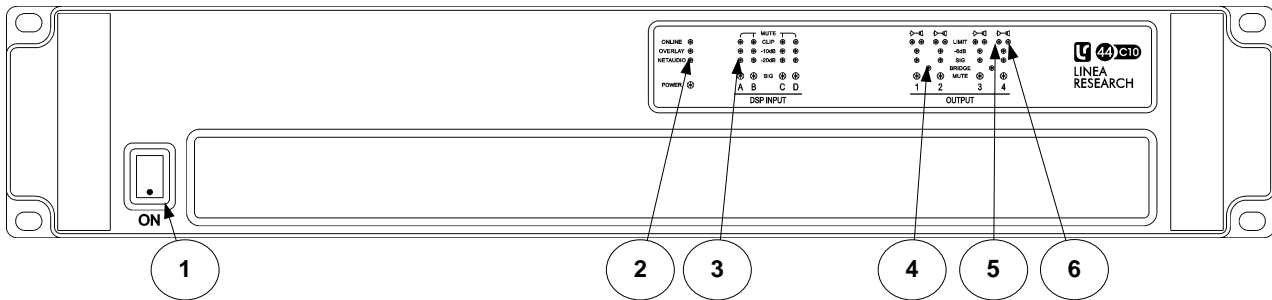

(The 44C is illustrated. The 88C is similar, but with more input and output indicators)

Power Switch(1)- Applies mains power to the device. If the device has entered Sleep mode, it may be woken up again either from the System Engineer application, or by switching this switch off, then on again.

Status Indicators(2)- The “**OVERLAY**” indicator shows when there are parameters active on a group layer, which the user cannot access through the front panel of the device (see [Overlay Flush](#)). The “**NETAUDIO**” indicator shows that a networked digital audio card is installed and routed (Such as Dante™). The “**ONLINE**” indicator has three states: *Off* – the unit is offline and not connected to a computer or network. *Flashing*- the unit is searching for an IP address; if the unit does not find an IP address the unit will assign itself an IP address automatically and the indicator will stop flashing. *On*- the unit is online and connected with software. IP settings can be viewed or changed within the <**UTILITY**> pages.

Input Signal Indicators(3)- A set of indicators show “**Sig**”, “**-20**”, “**-10**” and “**Clip (mute)**” for each of the DSP inputs “**A**” “**B**” “**C**” “**D**” (and “**E**” “**F**” “**G**” “**H**” on the 88C). The signal present Indicators operate at approximately –40 dBu. The **Clip/mute** Indicators warn the user of input overload and operate at 1dB before clip. This indicator also shows a muted input. The indicators in the input section are sometimes used to show progress of an action (a clockwise rotating wheel pattern), or confirmation of an action (e.g. an expanding square to confirm snapshot recall), or an error condition (‘Motorway’ hazard flashing).

Bridge Indicator(4)- This will illuminate when the channel pair is in Bridge mode. The controls for the left channel of the pair will determine the settings. See [Bridge Mode](#)

Amplifier Indicator(5)- This indicates when the amplifier protection systems are reducing the gain to keep the parameters of the amplifier within specification, or when that the channel is clipping.

Limiter Indicators(6)- The output indicators show the status of the limiter and output signal level. The level indicated is that before the limiter, referenced to the limiter threshold. The <**SIG**> indicator shows when a signal is present on the output. The second indicator <**-6dB**> shows that the signal has reached 6dB below the limiter threshold. The third (right-hand) <**LIMIT**> indicator indicates that the threshold of that output channel has been reached. This indicator (6) is also used to show action of the Thermal limiting action. Please note that because of the long release time of the thermal limiter, this indicator may remain illuminated for several seconds after signal on that channel is reduced. The indicators in the output section are sometimes used to show progress of an action (by illuminating progressively more indicators), or confirmation of an action (e.g. illuminating a number of indicators equalling the number of a Snapshot being recalled).

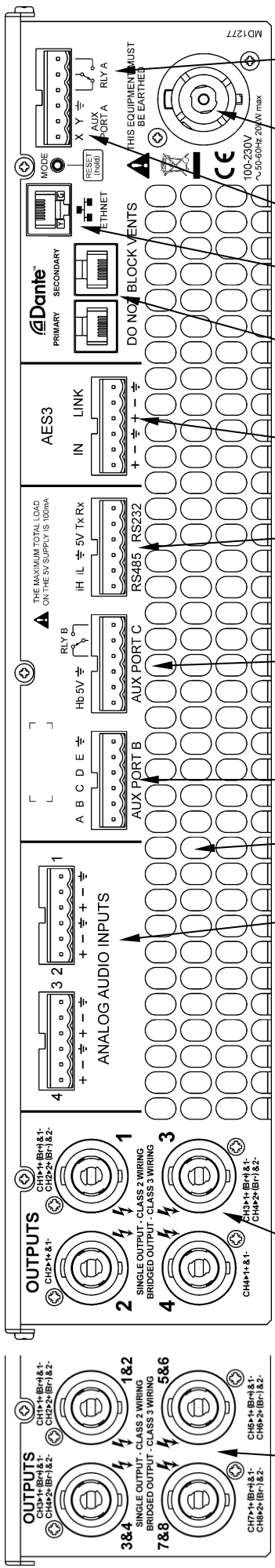

Relay output- This isolated relay output may be used to indicate abnormal conditions to external monitoring apparatus. See the [Fault Relay](#) section.

Mains Power Inlet- Connection to the mains supply must only be made with a genuine Neutrik™ Powercon™ 32A connector. The amplifier is designed to operate from a nominal mains voltage between 100V and 230V, 50/60Hz without re-configuration. NOTE: The amplifier **must** be connected to a suitable mains earth; failure to do so will affect safety, performance and will invalidate the manufacturer's warranty.

Auxiliary Port A- The default operation is X = Mute, Y = Sleep when connected to \perp (Ground / 0V).

Ethernet Communications Port- Used for remote control and monitoring via an external device, typically a Personal Computer, running an application such as Linea's System Engineer, or by using the simple Tipi protocol.

Networked Audio Ports (e.g. Dante)- Versions of the amplifier are available that support networked audio, if this option is not included a blanking plate will be fitted. There are several options for networked audio including Dante™ from Audinate™ Please consult your vendor for more details. NOTE: It is not possible to retrofit this option.

AES3 Audio Link Connector- The Link connections carry a buffered version of the signal on the AES3 input connections. In the event that an amplifier is not powered, AES3 input and Link are directly connected. Do not 'daisy-chain' more than 8 amplifiers from a single AES3 source.

Serial communications Connectors: The amplifier may be controlled via this 'third party interface' using either RS232 or RS485 (only one of these may be used at a time). Please refer to the "Tipi Interface Specification" document for details on how to use it.

Aux Port C Connector
Relay B output: This isolated relay output may be used to indicate abnormal conditions to external monitoring apparatus. The default operation is to indicate a Check Incident. See [Check Relay](#)
5V, \perp (Ground / 0V): This power output may be used for powering external indicators etc from either the Fault relay or Check relay for example. This output is not capable of supplying more than 100mA of current.
Hb: The Heartbeat output. This outputs a 5V 1Hz square wave all the time the unit is operating correctly.

Aux Port B Connector: Logic inputs. The default operation is to recall one of the Snapshots 1 thru 5 when connected to \perp (Ground / 0V), either momentarily or permanently.

Air Exhaust Vents- These must not be obstructed and there must be a clear path for hot air to exit any rack system.

Analogue Audio Input Connectors- All audio connections are fully balanced. The pins with the \perp symbol are connected directly to the chassis as required by the AES48 standard. NOTE: The 88C model has twice as many analogue input connectors, allowing for a total of eight analogue inputs

Loudspeaker Connectors (44C) - The numbered connectors carry their corresponding channels on the 1+ and 1- terminals. Connector 1 also carries the output for channel 2 on terminals 2+ and 2-. Similarly, connector 3 also carries the output for channel 4 on terminals 2+ and 2-. For Bridged mode, use terminals 1+ and 2+ of either CH1 or CH3. Only use genuine Neutrik™ Speakon™ connectors.

Loudspeaker Connectors (88C) - Odd channel numbers are connected to the 1+ and 1- terminals, even channel numbers are connected to the 2+ and 2- terminals. For Bridged mode, use terminals 1+ and 2+. Only use genuine Neutrik™ Speakon™ connectors.

Operation

Starting up the unit

When power switch is switched on the unit will go through its start-up cycle, checking all the sub-systems as it does so. Along the way, the indicators will inform you of its progress by lighting more indicators while the indicated progress 'wheel' turns to show activity. Once this is complete the indicators will take up their normal states.

Overview of Modules, Presets Components and Snapshots

A **Drive Module** represents a loudspeaker subsystem (e.g. Sub and Composite), and comprises one input channel and a number of output channels, associated with one-another by routing. The size of the Drive module is determined by the number of outputs in it. The device may contain up to four Modules (eight on the 88C).

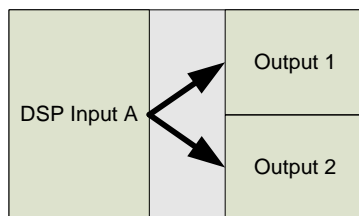

A **Module Preset** is a collection of settings (parameters) for a Drive Module of a particular size. The Preset contains a set of parameters for one input and a set of parameters for each of the outputs in the module. When a Module Preset is recalled, it will automatically change the routing between Input DSPs and Outputs, consuming a number of outputs according to the size of the Drive Module. Recalling a Module Preset thus always creates a Drive Module with consecutive outputs.

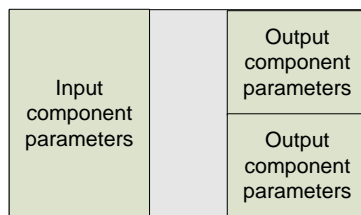

A **Component** is a collection of settings (parameters) for one (input or output) channel. Any one of the output components in a Module Preset may be recalled to any individual output.

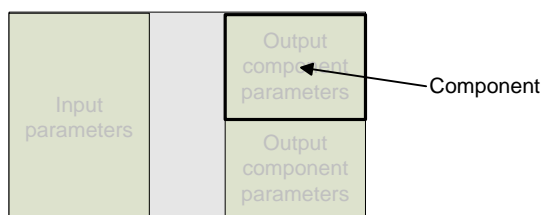

These concepts are depicted in the System Engineer application as in the following example of a 2-way Module:

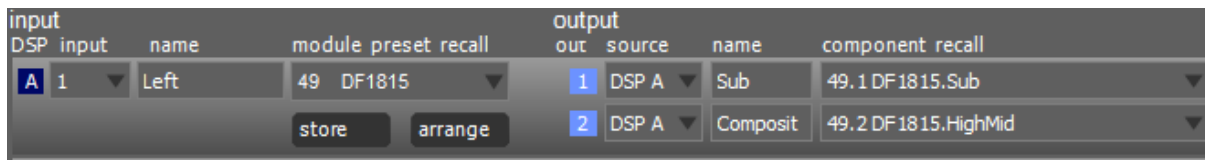

A **Snapshot** is a device-wide representation of most of the settings in the device. This is represented as four (44C) or eight (88C) Input Component numbers, four (44C) or eight (88C) Output Component numbers, plus a number of machine-centric settings such as routing and Input/Output Analogue/Digital selection etc.

44C:

Device Settings	Input A component number	Output 1 component number
	Input B component number	Output 2 component number
	Input C component number	Output 3 component number
	Input D component number	Output 4 component number

88C:

Device Settings	Input A component number	Output 1 component number
	Input B component number	Output 2 component number
	Input C component number	Output 3 component number
	Input D component number	Output 4 component number
	Input E component number	Output 5 component number
	Input F component number	Output 6 component number
	Input G component number	Output 7 component number
	Input H component number	Output 8 component number

Drive Module Presets

Presets do *not* change the settings device-wide. Rather, recalling a Module Preset creates a Drive Module by ‘consuming’ a number of consecutive outputs and setting up routing between the Input the preset was recalled on and those outputs. The parameters in that Drive Module are then set according to the parameters in the components in the Module Preset.

Note however, that modules with non-consecutive outputs can be created by manually manipulating the routing, and then recalling [Component Presets](#) to the individual outputs. The resulting system can then be stored in a [Snapshot](#). Such a Module cannot be saved in a Module Preset.

Note: When a Module Preset Recall consumes outputs to construct a module, it treats a pair of Bridged outputs as a single channel, so recalling a 2-way Module Preset will consume 3 output channels if a Bridged pair is encountered. See [Bridge Mode](#)

Note: DSP inputs are not the same as physical inputs. The 44/88 C Series has four audio inputs and four DSP inputs. This is a matrix mixing system where any physical inputs, be they analogue, AES3 or networked audio feeds, can drive any number of DSP inputs.

Component Presets

A Component Preset represents the processing for just one output. Any part of a Module Preset may be recalled to any one output. A Drive Module comprised of parameters which have been recalled to its outputs using Component Preset Recalls can then be saved into another [Module Preset](#) provided the outputs remain consecutive (i.e. you have not changed the routing manually). If the routing has been changed manually, then the whole arrangement may be saved into a [Snapshot](#). Also see [Snapshots](#) and [Recalling Components](#).

Factory Module Presets

The device may contain a library of *Factory Presets* designed to suit a range of enclosures.

Factory Presets may contain some parameters that are fixed and hidden from view; the remainder of the parameters are available for user manipulation in the System Engineer application. The number and type of hidden parameters is dependent on the Factory Preset, typically crossover frequencies, output delay and some EQs are hidden; those settings that are a function of the loudspeaker cabinet design and should not require adjustment for different applications. *Factory Presets* are locked (as indicated by a 'box' symbol after the Preset name) so they cannot be over-written. The user can, however, store an edited version of a Factory Preset in any free preset location.

In addition to the *Factory Presets* the device may have further '*Skeleton Presets*' which will help to create new presets. They can be used to develop settings for any loudspeaker combination and are recalled in the same way as the *Factory Presets* described above. These Presets are also usually locked but the user can name and store their own edited versions in any free preset location.

Storing Module Presets

Once a drive module has been created it can be stored by clicking the Store button in the Setup page in the System Engineer panel. You then select the preset number you wish to store the settings into, give the preset a Name, and select the name to be given to each Component in the preset. Finally, click the Store button.

Note: Storing a Drive Module preset for a module which is not configured with consecutive outputs is not permitted.

Recalling Module Presets

To recall a Drive Module preset, click the arrow in the module preset recall control in the System Engineer control panel, select the appropriate preset from the list by clicking on it. Note that presets do not contain and do not disturb parameter Overlays. See [Overlays](#)

Recalling Components

To recall a Component Preset (to a single output), click the arrow in the component recall control in the System Engineer control panel, select the appropriate component from the list by clicking on it. Note that component presets do not contain and do not disturb parameter Overlays. See [Overlays](#)

Also see [Snapshots](#).

Input

AES3 Inputs

In addition to the usual analogue inputs, the Device can also accept two channels (one stream) of AES3 digital inputs. There is no 'standard' for the relative gains between Analogue and AES3 so depending on the levels delivered by the audio source, it may be necessary to adjust the digital input gain trims to normalise them. It is possible to change the gain of the AES3 input (when AES3 is selected) by adjusting the *trim* parameter in the Tools>inputs view of the System Engineer panel. For example, to achieve 0dBFS = +18dBu, set the AES3 trim to -2dB. To achieve 0dBFS = +24dBu, set the trim to +4dB.

This device will automatically lock onto any sample rate within the range 28kHz and 108kHz.

Networked Audio (Dante) Inputs

When the Digital Audio Network option is fitted, it is possible to select any channel(s) as being sourced from this network. To do this, connect the audio network connection to the connection on the rear of the Device, and set the relevant Input Type parameter to "Dante" (for example.)

When the Digital Audio Network input is installed and routed, the "Net Audio" indicator will illuminate. This indicator will come on even if there are no cables plugged into the networked audio port on the Device.

As for the AES3 inputs, it is possible to change the gain of the Dante input (when Dante is selected) by adjusting the *trim* parameter in the Tools>inputs view of the System Engineer panel.

The amplifier will automatically select the correct sample rate from the incoming stream.

For other details on the operation of the Digital Audio Network, please refer to the relevant manufacturer's documentation.

Automatic Input Selection (Failover)

It is possible to configure the input selection to be automated. The Tools>inputs view in the System Engineer panel has a *failover* parameter for each physical input, which defaults to Manual, allowing you to select what type of input you wish to use. When Failover AES3>Analogue is selected (on an input channel which supports AES3), then the AES3 source will be automatically selected if it has a valid audio stream on it. If the AES3 stream should fail, then Analogue is automatically selected instead.

When Failover Dante>Analogue is selected (when the Dante option is fitted), then the Dante source will be automatically selected if it has a valid audio stream on it. If the Dante stream should fail, then Analogue is automatically selected instead.

Similarly, it is possible to select Failover Dante>AES3 on a channel that supports AES3 and the Dante option is fitted.

The 'Auto' setting allows the highest priority input source that is active to be automatically selected, so the user could just plug a source into any input and it will be automatically selected. The priorities are: Dante first, AES3 second, Analogue third.

Note that any automatic selection will take precedence over manual selection, so if you try to manually select Dante when there is no valid Dante stream, then it will revert to the failover input source.

Gain and Polarity

The Input 'strip' in the gain/delay view of the System Engineer panel allows you to increase or decrease the amount of signal going into any given input DSP by adjusting the *gain* parameter. The presence of an active Group Overlay *gain* parameter is indicated by a *gain* value being shown in square brackets e.g. [-1.4dB] under the *gain* control. This shows the total combined gain of all layers, including the value of the gain control above it.

The strip also allows you to change the polarity of the selected input from normal to reverse, and to mute the selected input DSP channel. The mute button alternately flashing green/red indicates the presence of an active Group Overlay mute parameter.

Delay

The Input 'strip' in the gain/delay view of the System Engineer panel has a *delay* parameter which controls the amount of delay associated with a given input DSP channel, and is adjustable from 0 to 998ms. The *delay* parameter is adjustable in fine steps at low values; the adjustment becomes progressively coarser as the value increases. The presence of an active Group Overlay *delay* parameter is indicated by a delay value being shown in square brackets e.g. [1.23ms] under the *delay* control. This shows the total combined delay of all layers, including the value of the delay control above it. See [Overlays](#).

High Pass Filter

System high pass filtering is provided for the input signal. Filter type is selectable from 1st order, Butterworth, Bessel, Linkwitz-Riley and Hardman. Filter slopes of up to 4th order or 24dB / octave are provided. Not all filter types are available in all slopes. For example 18dB / octave Linkwitz-Riley filters do not exist.

The Hardman type filter is always described by its order as the filter becomes progressively steeper rather than following a linear slope so a dB/octave description is not accurate.

Parametric Equalisation

There are nine stages of equalisation available for each input channel, three shelving filters and six parametric filters. Equalisation is accessed by clicking the EQ navigation button in the System Engineer panel. The presence of an active Group Overlay EQ is indicated by an olive coloured EQ curve being shown. This shows the total combined EQ of all layers. See [Overlays](#).

FIR Shelving EQ

The Input High Shelf EQ is implemented using a Finite Impulse Response (FIR) filter, and exhibits a linear phase response; that is all frequencies are delayed by the same amount. This can be important in applications where different amounts of EQ are applied to different parts of a speaker cluster, such as to add 'Throw' EQ boost so that parts of cluster which are throwing further can have HF absorption correction added. If this EQ is not linear phase, then the zones where the speakers combine may suffer frequency response anomalies.

Being a linear phase FIR equaliser, this necessarily introduces some latency delay, which is constant regardless of the settings. However, when the 'Enable' parameter is set to "Off", it is removed from the signal path entirely, so it does not add any latency. In this page you can change the frequency parameter from 2kHz to 20kHz, enable/disable the filter, and change the cut or boost in 0.2dB increments. The filter (and its associated latency) can be completely removed by setting the enable parameter to the "Off" position. Note that this EQ must be set to 'On' if you wish to use it in Module Groups.

Also see [Latency Delay](#).

Parametric Filters

Parametric filters are defined by frequency, bandwidth and gain. The frequency is adjustable over the range from 10Hz to 25.6kHz. The bandwidth shown as Width on the screen, ranges from 0.10 octaves to 5.2 octaves. Bandwidth can be shown and adjusted as Q or Octaves (Oct). Gain is adjusted in 0.2dB increments.

Routing

The *input* parameter in the setup view of the System Engineer panel allows you to route any physical analogue or digital signal channel to any DSP input. This is effectively a matrix mixing system where all DSPs can be driven from any one input, or from combinations of inputs. Summed inputs have appropriate attenuation so that a sum of largely similar programme material remains at the correct calibrated level.

Output

Gain and Polarity

The Output 'strip' in the gain/delay view of the System Engineer panel allows you to increase or decrease the relative signal gain for any given output. The Gain value may be adjusted in 0.2dB steps from -40dB to +20dB. You can also change the polarity of the output from normal to reverse and mute it.

Delay

The Output 'strip' also allows you to control the amount of delay associated with that output channel, and is adjustable from 0 to 998ms. The *delay* parameter is adjustable in fine steps at low values; the adjustment becomes progressively coarser as the value increases.

High and Low pass Filters

The xover view of the System Engineer panel provides access to High pass and Low pass crossover filtering for the output. Filter type is selectable from 1st order, Butterworth, Bessel, Linkwitz-Riley, Hardman and LIR Linear Phase. Filter slopes of up to 8th order or 48dB / octave are provided. Not all filter types are available in all slopes. For example 18dB / octave Linkwitz-Riley filters cannot be selected because they do not exist.

The Hardman type filter is always described by its order as the filter becomes progressively steeper rather than following a linear slope so a dB/octave description is not accurate.

LIR Crossover Filtering

Unique to Linea Research, "Linear Impulse Response" (LIR) crossover filtering gives a Linear Phase crossover which has a constant delay regardless of frequency (unlike other types of crossover which delay different frequencies to a different extent, thus smearing the arrival time). The LIR crossover can thus be described as having a flat Group Delay response, and thus entirely free of Group Delay Distortion, this is exactly the same as can be provided by common FIR filtering but without the complications and disadvantages inherent with the FIR technique.

The shape of the LIR crossover filter is similar to a 4th order Linkwitz-Riley filter, and maintains zero phase difference between the adjacent bands across the crossover region to keep the polar response rock steady.

Note that very narrow bandwidths are not possible with this crossover type. If the Low Pass frequency is too close to the High Pass frequency, then the filter will 'mute'.

Linear Phase filtering necessarily introduces delay; the laws of physics demand it. To keep this delay to a minimum, it is recommended that more conventional crossover shapes (such as Linkwitz-Riley) are used for the very lowest frequency high-pass edge, particularly if this is less than perhaps 100Hz, which is well below the frequency thought to cause audible 'Group Delay Distortion'.

This constant delay will depend on the lowest high-pass frequency used in the crossover filters in a given Drive Module.

Also see the section on [Latency Delays](#).

Parametric Equalisation and All-Pass Filters

Equalisation is accessed by clicking the EQ navigation button in the System Engineer panel. There are ten different EQ filters; two shelving filters and eight parametric filters. Parametric filters are defined by frequency, bandwidth and gain. The frequency is controlled over the range from 10Hz to 25.6kHz. The bandwidth, shown as Width on the screen, ranges from 0.10 octaves to 5.2 octaves. Bandwidth can be shown and adjusted as Q or Octaves (Oct). Gain is adjustable in 0.2dB increments.

Any of the six Parametric filters can be used as All-Pass filters. This setting is engaged or disengaged by right-clicking the EQ 'icon' in the EQ window of the System Engineer panel.

FIR Filter (available on some models)

Each output supports a 768 tap Finite Impulse Response (FIR) filter which may be programmed using a third party application, such as the Eclipse Audio FIR Designer software, and loaded via the System Engineer application.

FIR filters may be used for equalisation, phase manipulation or for crossover filtering with linear or arbitrary phase response.

Limiters

The 44/88 C Series includes three limiters in the output signal path, accessed by clicking the xover button in the System Engineer panel. Please note that whilst the Limiters in this product offer protection for amplifiers and drivers, they can never protect from all possible scenarios, therefore Linea Research is not responsible for any damage which might occur.

VX Limiter (Unique to Linea Research)

This is a peak-detecting RMS-calibrated signal limiter. The VX Mode parameter determines the style of limiter. When Virtual Crossover (VX) mode is off, the limiter is controlled in a conventional manner; the only controls being Threshold and Overshoot.

The Overshoot limiter prevents the signal from exceeding threshold by more than a predetermined amount during the attack phase of the main limiter. The optimal Overshoot setting is usually about 8dB. Lower Overshoot settings will sound progressively 'harder'.

When VX mode is engaged, the user can choose the crossover point of a 'virtual crossover', which incorporates two limiters per output so the user can individually limit the drivers in a passive 2-way enclosure using individual thresholds, and optimised attack and release characteristics for each. The Threshold of the second 'Hi' limiter is set relative to the threshold of the first 'Lo' limiter.

The effect of the VX threshold and split frequency on the Limiter curve can be seen in System Engineer.

This Limiter introduces some delay. In non-VX mode, this delay will depend on the lowest high-pass frequency used in the crossover filters in a given Drive Module. In VX mode, the delay is related to the Split frequency. This delay will be applied to all of the outputs in a given Drive Module to keep them in phase.

Also see [Latency Delays](#)

Tmax Thermal Limiter

The Thermal Limiter is intended to protect the driver against damage due to over-heating. It models the temperature of the driver, and constrains the output signal level in order to keep the average output power

below a predetermined limit, applying attack and release characteristics to go some way towards modelling the complex thermal circuit of a driver's voice coil and magnet assembly.

Three parameters are available for adjustment:

Threshold – the continuous RMS voltage which the driver should be able to withstand. This is calibrated at the output of the amplifier. The Thermal Limiter can be defeated by setting the Threshold to the maximum "Off" value.

Attack – The time-constant of the speed at which the driver heats up (in seconds).

Release – The time-constant of the speed at which the driver cools down (expressed as a multiple of the Attack time).

Bridge

When an amplifier pair is set to Bridge Mode, it uses two amplifier channels to drive one loudspeaker with greater power. In this mode, only one set of Output controls is active per pair of amplifier channels since both of the amplifiers in the pair are driven with the same signals, as determined by the left-hand (lower numbered) channel of the pair controls. Bridge settings should be set up *before* recalling [Drive Module Presets](#). Module Preset Recall will see a bridged pair of outputs as a single channel.

Bridge Mode is enabled or disabled in the setup page of the System Engineer panel. When enabled, the Bridge indicator on the device will be illuminated between the bridged channels.

When Bridged, the partner (even numbered) channel will not show any signal on the limiter meter, neither will you be able access any of its parameters for adjustment. The Amplifier protection indicator however will still operate.

Routing

The setup button in the System Engineer panel allows you to change the *source* from which each output derives its drive signal. An output can be driven from any DSP input. This routing is the fundamental means by which Drive Modules are created. When a Module Preset is recalled, automatic routing will always consume outputs consecutively alphabetically and numerically. However, non-consecutive Drive Modules may be created using manual routing and [Recalling Components](#). See the [drive module](#) section of this user manual for more information.

Dante Outputs

When fitted with the Dante option, it becomes possible to route signals to the Dante Outputs. The signal on each of these Dante Outputs may be selected from one of the following:

- "Input" – Selects the signal which is being presented to the input of the input processing channel for the similar numbered input channel (i.e. the input of the 'Input DSP')
- "Input DSP" - Selects the signal which emanates from the output of the input processing channel for the similar numbered input channel (i.e. the output of the 'Input DSP')
- "Pre Mute" – Selects the signal at the output of the equalisation section of the similar numbered output channel (i.e. the fully processed output signal before Gain, Mute and Limiting functions)
- "Post Mute" – Selects the signal at the output of the Gain, Mute section of the similar numbered output channel (i.e. the fully processed output signal before the Limiter functions)
- "Post Limiter" – Selects the signal at the output of all the output processing functions (i.e. the fully processed output signal, identical to that of the main amplifier output)

For further clarity, see the [processing block diagram](#).

Driver

The optimal drive level may be adjusted for a given driver impedance using the *load* parameter by clicking the gearwheel and selecting the appropriate output. See [Load Matching](#).

The live measured impedance value is also shown in this view page. Since the device can only measure this when there is a signal, the impedance is indicated as “?” when there is insufficient signal level to perform a measurement. You can restrict the range of impedances which will be considered normal by setting *min. imp.* and *max. imp.* to values other than “Any”. Please note that the measured impedance may depart dramatically from the rated impedance due to variations in impedance for different frequencies for a given loudspeaker. If the measured impedance should fall outside this range, then a Check incident will be raised. See [Incident Reporting](#)

Stereo Linking

Linking may be changed in the gain/delay view of the System Engineer panel. Each ‘strip’ contains a stereo link button. Stereo linking is available between DSP Drive Modules A & B and between C & D (and between E & F and between G and H for the 88C model). When stereo linked, adjusting a parameter in either of the stereo linked Drive Modules will then change the other linked Drive Module to the same value.

Note: Stereo linking will only work when the linked Drive Modules are of equal size.

Note: Stereo Linking state is not stored in Presets (but is stored in Snapshots)

IP Address

This may be viewed and edited in the tools>networking page of the System Engineer panel.

The *current IP address* cannot be edited; it simply shows you what IP address the device is currently using.

The Ethernet IP address may be automatic “**Auto**” or may be a fixed static value “**Static**” as determined by the *IP mode* button.

WARNING – Do NOT use Static mode unless your IT system specifically requires it. Auto mode should always be used where possible since in this mode, the Device can always be ‘discovered’ by the System Engineer application.

If you cannot communicate with the device and the IP address of the device is in an unknown state, you can restore it to Auto mode by pressing and holding the recessed button on the rear of the device for about 10 seconds.

The *static IP address* may be edited by typing numerical values into the four boxes. The new value will not take effect until you click **apply**. The new IP address will then be checked to ensure it is ‘legal’. If it is legal, the device will be instructed to change to this IP address. If you were online to the device in static IP mode, it may be necessary to go offline, then back online again.

Also see [Ethernet Configurations](#).

Store Snapshot

The setup view of the System Engineer panel has a *setup snapshots* section. This allows a Snapshot of the device to be stored into the device. A snapshot can also be recalled (activated) from here. Snapshot may also be recalled from an Aux port, or by using the *Tipi* third party interface protocol.

Also see [Snapshots](#), [Aux Port](#) and [Tipi Third Party Interface](#)

ECO

The setup view in the System Engineer panel has a *power options* section. This allows the device to save power by going into a low power mode when it is not being used.

Standby is a fast mode which saves some energy, but will wake-up very quickly if an audio input is detected. The associated *standby time* parameter allows the amplifier to automatically go into power-save if no audio signal has been detected for a period of time. This function can be defeated by setting the latter control to Manual. Linea would strongly advise leaving it set to automatic however as there is no negative consequence to doing this since 'wake-up' on detecting the presence of an audio input signal is instantaneous.

The *standby* button allows the amplifier to be put into standby mode manually when it is not being used.

Sleep is a deep power save mode which saves the most energy, however it will take a small number of seconds for the amplifier to wake-up, and it may only be woken up manually (either from the System Engineer application or by switching the device off then on again). The associated *sleep time* parameter allows the amplifier to automatically go into Sleep mode if no audio signal has been detected for a period of time. This function can be defeated by setting the latter control to Manual. The *sleep* button allows the amplifier to be put into sleep mode manually when it is not being used

External Breaker Protection (EBP)

The *External Breaker Protection* (EBP) feature, allows the output power to be limited in order to prevent the nuisance tripping of mains circuit breakers or fuses when the amplifier needs to be operated on a mains supply with restricted capacity. Set the EBP value to that of the circuit breaker or fuse to which the amplifier is connected. You can view the current being drawn from the mains supply in the *draw* box.

Ethernet

Ethernet configurations

IP addressing in the Device can be completely automatic; No setup is required.

When first installing and launching System Engineer, the computer Firewall may ask to allow System Engineer to access the network. **NOTE: This must be allowed for both private and public networks.**

DHCP

There are two primary IP address ranges – one used when there is a DHCP server, and another ('Link Local') where there is no DHCP server (so the Device and the Computer will instead use 'Auto IP' to allocate themselves an IP address). Both the device and the computer must be in the same IP address range. In a local network environment such as an office where there is a DHCP server, both the computer and the Device will be in the DHCP IP address range, and so will connect immediately.

AUTO-IP

The device will initially search for a DHCP server when first switched on (during which time its Online Indicator will be flashing). As it can take up to one minute to establish that there is no DHCP server available, this is the time it may take before Auto IP is entered.

Please be aware that it can also take some time from a computer being switched on in an isolated network (without a DHCP server), or unplugged from a network with DHCP to time out of DHCP searching, so it will not connect immediately to amplifiers that are already using Auto IP. The time it takes before it decides to revert to Auto IP depends on the operating system but it can take several minutes to acquire an Auto IP address.

Static-IP

If the device or the computer has a static IP address set, System Engineer may not be able to 'see' the device if it is in a different IP Address range (i.e. in a different *subnet*). ***Unless there are good reasons it is best to avoid the use of static IP addressing if at all possible.***

IP Troubleshooting

If System Engineer cannot connect to the device:

- A Router acting as a DHCP server is highly recommended as this provides the most trouble-free way of administering IP addresses. Always switch on any DHCP server before connecting either the computer or Amplifier to the network.
- If not using a DHCP server, check that the Current IP address in the device is compatible with the IP address of the computer. Generally, the leftmost two sets of 3 digits should be the same.
- If there is no Router in the system acting as a DHCP server, wait 10 minutes (for the computer to acquire the correct IP address) and try again.
- Check that the Firewall in the computer will allow System Engineer access to the network ***for both private and public networks***. Please refer to the Help feature in the System Engineer application for further guidance on this

Snapshots

A Snapshot may be recalled either from the System Engineer application or via the AUX port on the rear of the Device, or by using the third party interface protocol, Tipi.

Recalling a Snapshot triggers the recalling of a Component to each input and output, and may change other device-wide settings, effectively recalling a processor-wide 'preset'.

Regardless of the source of a Snapshot recall, any change in the snapshot number will be associated with the 'expanding box' pattern on the left-hand indicators, and a number of indicators on the right-hand side indicating the new snapshot number.

Also see [Aux Port](#) and [Tipi Third Party Interface](#)

The parameters inside the Drive Modules are not individually stored in Snapshots. Recalling a Snapshot will merely trigger the recall of the appropriate Input and Output Components, rather than restoring the parameters that were active when the Snapshot was stored. This has the distinct advantage that the library of OEM presets may be updated without having to be concerned about what parameters might have been saved in users Snapshots. It does however require that any existing edits to the parameters in Drive Modules are stored into Drive Module presets before a Snapshot is stored.

Also see [Overview Of Modules Components and Snapshots](#)

AUX Port A

The AUX A connector has two inputs, X & Y. These allow simple contact closure devices (relays or switches) or external logic signals to change the state of the amplifier as described below. Connecting an AUX input to ground (the earth symbol) will trigger it; there is no requirement for an external voltage. However, the ports can also be triggered directly by a logic signal as long as the logic 'low' goes below +0.5V. ***Do not connect systems if their logic 'high' voltage exceeds +24V.***

The action is: X = Mute when connected to Ground (0v), Y = Sleep when connected to Ground (0v).

Fault Relay A

Three connections are available via a Phoenix connector for this relay. The schematic representation printed on the rear panel shows the 'idle' state of the relay (when the amplifier is not switched on). When the amplifier is switched on, the relay will normally energise. When a Fault incident occurs, the relay will be de-energised. This will allow either a Fault Incident or a loss of power to be seen as an 'Incident'.

AUX Port B

The AUX B connector has five logic inputs. The default operation is to recall one of the Snapshots 1 to 5 by applying a Ground (0v) to one of these pins, either momentarily or permanently.

NOTE: That if this port is being driven by a Ground (0v) on any input, this will override a snapshot recall over the third party Tipi interface or in System Engineer.

Also see [Snapshots](#).

Check Relay B

Three connections are available via the Phoenix connector for this relay. The schematic representation printed on the rear panel shows the 'idle' state of the relay (when the amplifier is not switched on). When the amplifier is switched on, the relay will normally energise. When a Check incident occurs, the relay will be de-energised. This will allow either a Check Incident or a loss of power to be seen as an 'Incident'.

Also see [Incident Reporting](#)

AUX Port C

The AUX C connector carries:

- 5v, Gnd: This power output may be used for energising external indicators etc from either the Fault relay or Check relay for example. This output is not capable of supplying more than 100mA of current.
- Hb: The Heartbeat output. This outputs a 1Hz square wave all the time the unit is operating correctly.

RS232/ RS485

Serial communications Connectors: The device may be controlled via this 'third party interface' using either RS232 or RS485 protocol at a rate of 38.4k Baud. Only one of these may be used at a time. Please refer to the "Tipi Interface Specification" document for details on how to use it.

Also see [Tipi Third Party Interface](#)

Latency delay

All Digital Signal Processing, and conversion between different formats of signal – analogue/digital/network etc., necessarily introduce some delay (latency) to the signal path. Of course, we strive to minimise these latencies. Small as they are, it is sometimes useful to know their precise values. The following describes the principal latencies introduced by various parts of the Device:

Input/Output Latencies

	Analogue Input	0.385ms
OR	Digital input at 96KHz sample rate	0.5ms
OR	Digital input at 48KHz sample rate	0.66ms
	Analogue Output	0.402ms
OR	AES3 Output	0.1ms
OR	Dante Output	1.29ms @44.1kHz
	(Excluding Dante network latency)	0.68ms @48kHz
		0.45ms @96kHz

Processing Latencies (limited to a minimum of 1.57ms):

	Input HiShelf FIR	0.4ms (0ms if set to 'Off')
	LIR Linear Phase crossover	1.19ms/Fhp(kHz), limited to 30ms maximum **
	VxLim Limiter (VX mode off)	0.12ms/Fhp(kHz), limited to 1.57ms maximum **
OR	VxLim Limiter (VX mode on)	0.358ms/Fsplit(kHz), limited to 1.57ms max ††

Where Fhp is the High-Pass crossover frequency

** This latency figure is calculated using the crossover High-pass frequency (in kHz)

†† This latency figure is calculated using the Vx Split frequency (in kHz)

Important tip: The processing latency is constant at 1.57ms unless LIR crossover filters or FIR HiShelf EQs are used, so normally you would just need to add the Input and Output delays to this constant value. If LIR or FIR are in use, the Processing latency of a Drive Module may increase beyond this figure.

When LIR, is used the Vx Limiter can take the overall latency above the 1.57ms. When high pass frequency is set below 40Hz the filter will automatically revert to Linkwitz riley, this is set so that the latency will not exceed 30ms as stated.

Example:

Input/Output	
Analogue Input	0.385ms
Analogue Output	0.402ms
Processing	
Input HiShelf FIR (Off)	0ms
LIR Linear Phase crossover (500Hz)	2.38ms
VxLim Lim (VX mode on, 1KHz Fsplit)	0.358ms
Total	3.525ms

Note that the latencies within a Drive Module are equalised among outputs of that Drive Module. That is, padding delay will be automatically added to some outputs such that the total latency is the same in each output of a Drive Module. On models which have Output FIR filters, these may declare latency which will also be compensated for. This latency equalisation does not extend outside a Drive Module, so Drive Modules are not guaranteed to have the same latency as one-another.

Overlay Flush

If the device has been used in Module Groups, and still has an active Overlay (as indicated by the Overlay indicator), these can be removed in the System Engineer application by selecting Modules mode and removing any modules for this device from all groups. See [Overlays](#).

Revert to Factory Settings

If you wish to erase all of your settings and revert everything to factory settings, then simultaneously press and hold for 5 seconds the Up button and the Mute 1 button, then follow the prompts on the display. Only continue by pressing the Enter button if you are sure this is what you want to do. Otherwise, press the Down button to escape. Alternatively, you can access this feature from System Engineer application using the 'Hamburger' button on the bottom-right of the device control panel, selecting 'revert to factory settings'.

Protection Systems

Comprehensive protection features preserve the longevity of the loudspeaker and amplifier by continuously monitoring several critical parameters, and reducing the gain, or muting the amplifier either temporarily or permanently depending on the nature and seriousness of the fault or misuse. The amplifier will recover and restart if at all possible, but may remain in shut down if a serious fault persists.

Limiters deal with routine over-driving of the amplifier, making sure that the driver(s) are not pushed too hard. The limiter indicators will warn you when the driver is being driven into limit.

Minor faults are dealt with by 'dimming' the amplifier, reducing the level to a sufficient degree and for a sufficient time that the amplifier is able to recover gracefully without any user interaction. When the fault condition has passed, the amplifier will recover automatically.

When the protection systems are reducing the level, this is indicated by illuminating the left-hand Amplifier channel protection indicator. This will also illuminate when the output voltage is 'clipping'. This indicator will remain permanently illuminated if the channel has been muted by the protection systems. The Mute button will also flash. Some types of protection affect all output channels, so you may see the Amplifier indicator illuminated, and the Mute indicator flash, on every channel. Note that the 'Locate' feature in System Engineer will also cause the Mute indicators to flash.

Summary of Protection Indication

The reasons for the protection indicators illuminating are summarised as follows:

Amplifier Indicator	Driver Indicator	Notes
	Limiter 6dB over	
	Thermal limiting	
Amplifier clipping		
Amplifier clip limiting		
Amplifier Current limiting		
Amplifier VHF limiting		
PSU Current limiting		Will show on all output channels
PSU Power limiting		Will show on all output channels
Thermal limiting		Will show on all output channels

Incident Reporting

In the System Engineer application, a coloured indicator appears on a Device Bar in the System View which displays the Incident state of the device. The Incident state may be one of three states:

- Red: Fault (The device is faulty in some way and requires attention)
- Yellow: Check (The device may not be performing to its full and should be checked)
- Green: OK (The device is performing well and requires no attention)

Holding your mouse over the Incident indicator for a few seconds will show the current incident level and name.

If an incident is reported you can disable it, and all less serious incidents, by right clicking the bar in System View and selecting 'Enable/Disable Alarms'. Doing this will show a cross over the Incident indicator and the device will no longer report any Incidents at this level or below.

If any Incidents have previously been disabled they can be enabled by using the right click context menu and selecting 'Enable/Disable Alarms' again.

A Fault state will also cause the Fault Relay to open. See [Fault Relay](#)

A Check state will also cause the Check Relay to open. See [Check Relay](#)

Performance Logging

The System Engineer application allows you to inspect various performance measurements, including various graphs of performance against time, recording events over a period of up to three days. Since the amplifier cannot record any events whilst powered-off, breaks in a log due to power-downs are indicated by a break symbol || in the log.

The events recorded are:

Supply Current - How much current is being supplied to the device via the mains inlet

DC Link Voltage – A voltage which is derived from the mains supply voltage

Thermal Capacity – How much of the available thermal capacity has been used

Driver Current (for each output) – The average current being delivered to the driver

Driver Impedance (for each output) – The average impedance of the driver

Protection Limiting (for each output) - How much the amplifier is 'dimming' itself in order to protect itself from potential damage

The data in the log can be exported by right-clicking on the log to launch a context menu, and selecting "copy log data to clipboard". The data could then be pasted into a spreadsheet for further analysis. Your dealer may ask you to do this if you have experienced a problem.

Alternatively, all of the operational and performance data, including the logs may be collected together into a single file by selecting File > Save Device Diagnostics. Your dealer will be able to read and interpret this data.

Tipi Third Party Interface

Whilst the device can be set up and controlled entirely using a dedicated control panel in the System Engineer PC application, Tipi provides a powerful yet very simple means of controlling the device using ASCII strings from a very wide range of controller devices. The Tipi protocol will operate either via the RS232/RS485 Serial interface, or via TCP/IP on the Ethernet interface. For a full list of Tipi command strings and settings, please refer to the Tipi Protocol document.

Processing Block Diagram

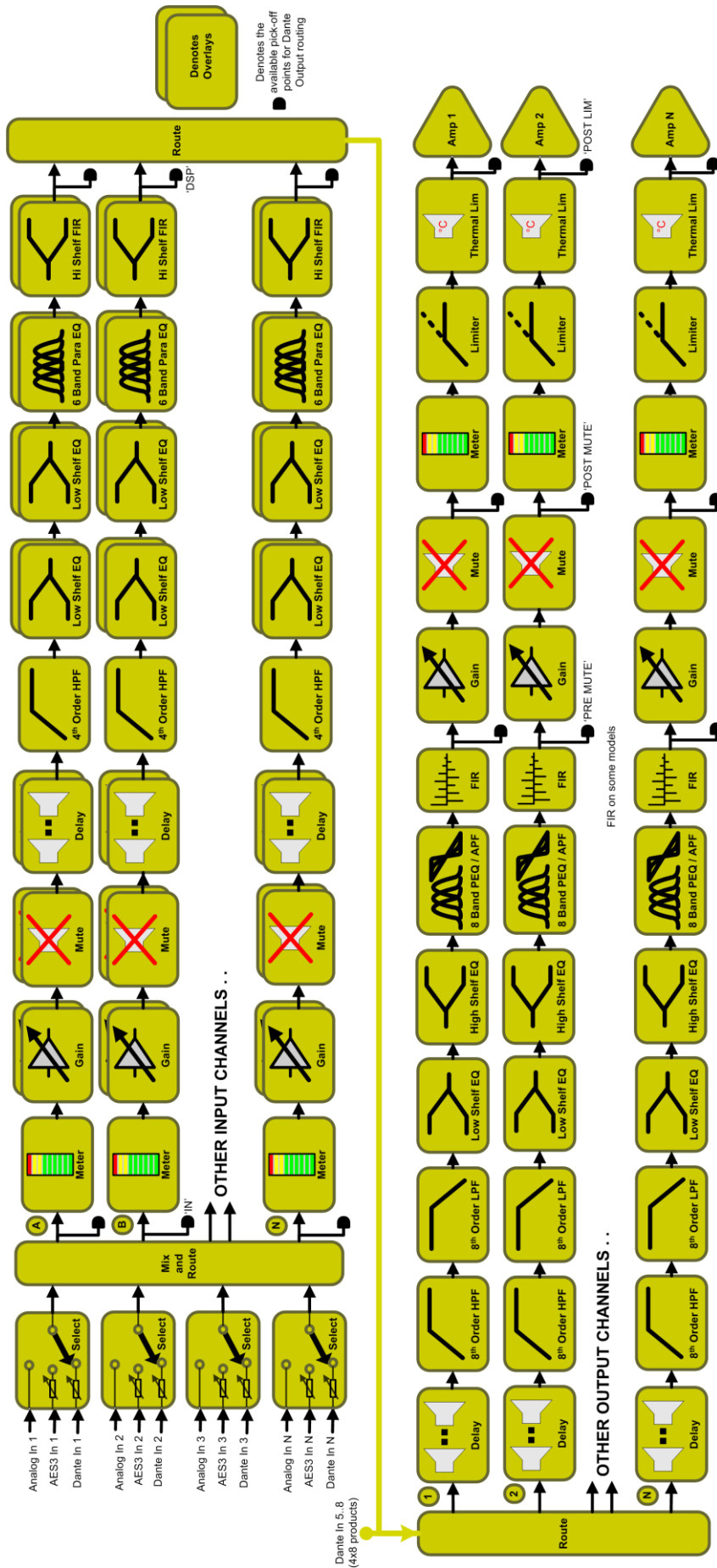

EQ and Filter Response Graphs

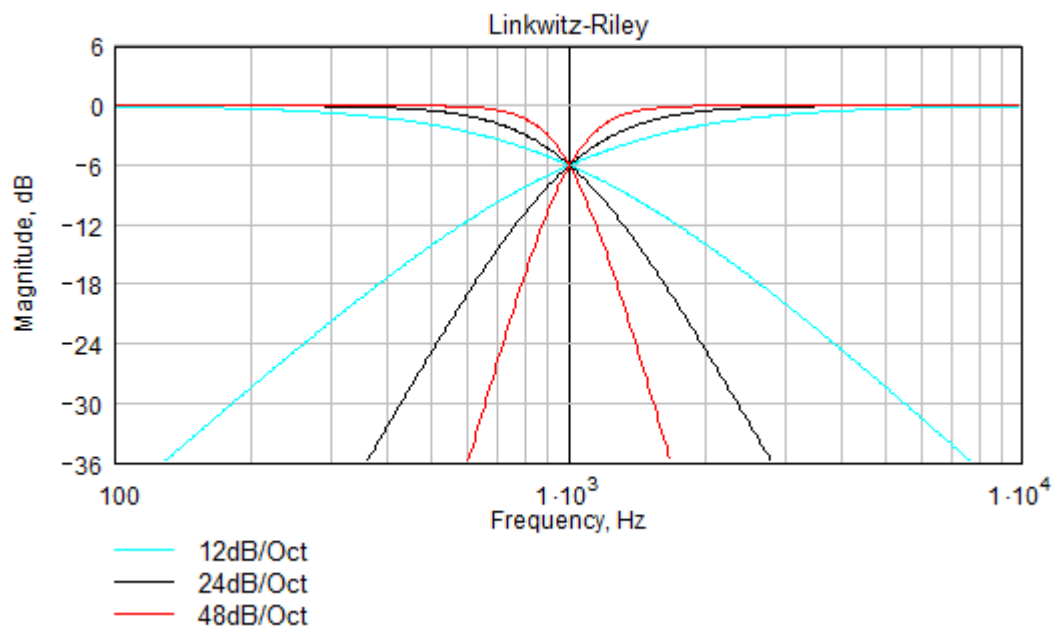
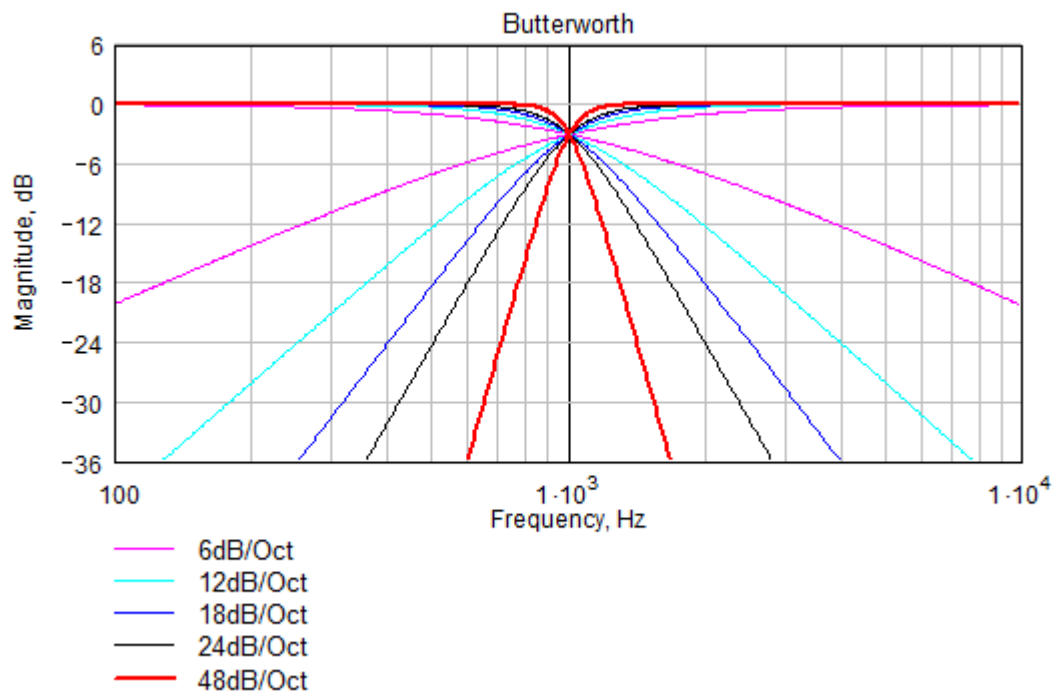

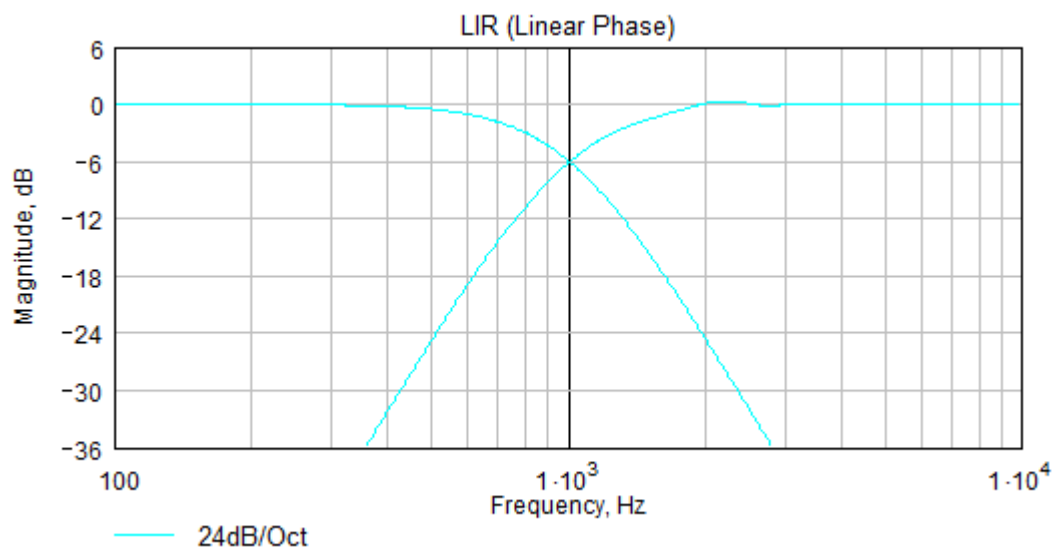
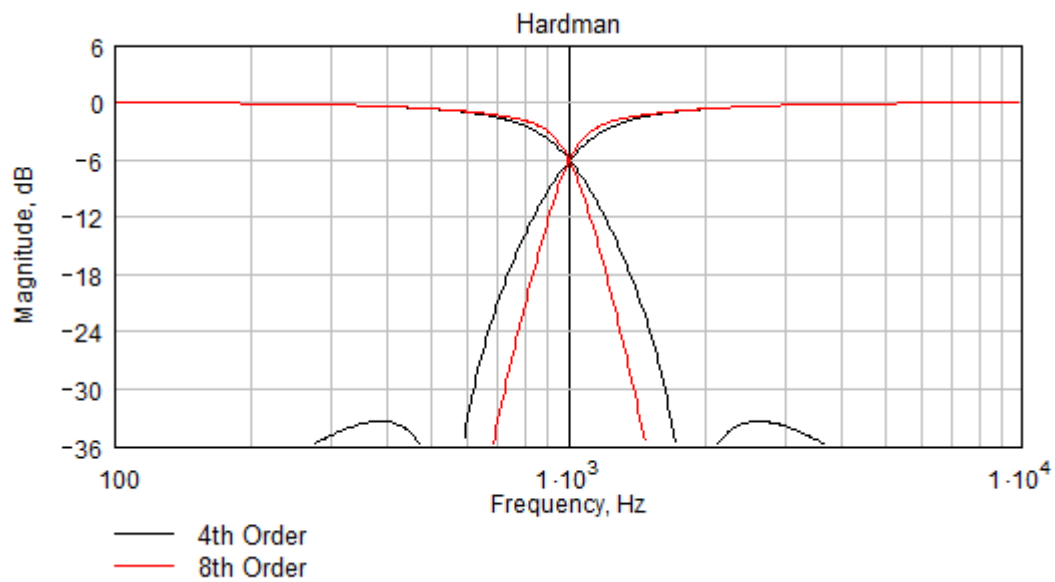
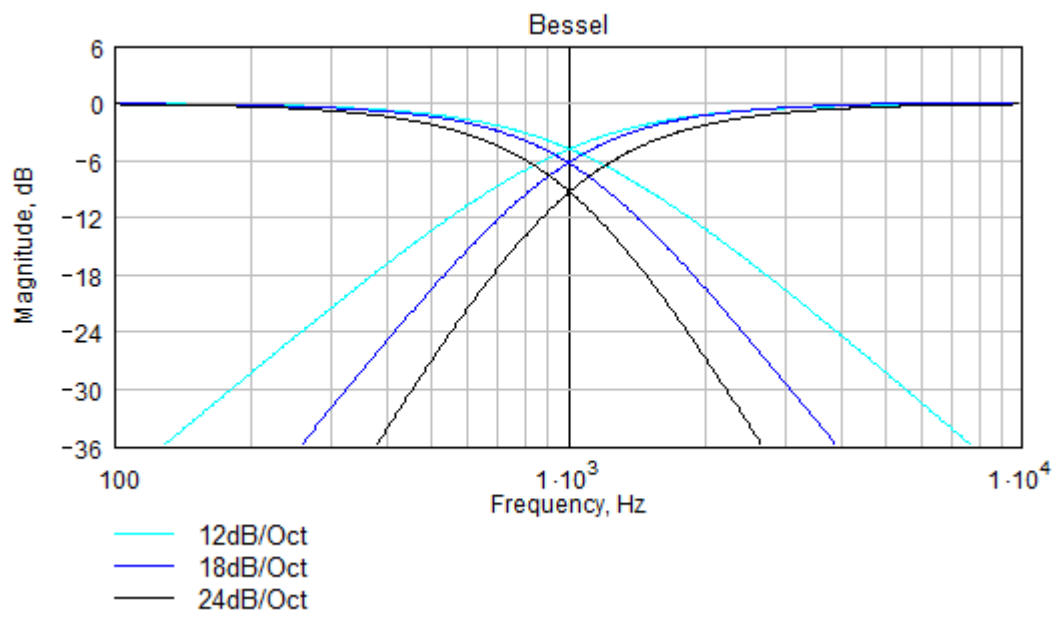

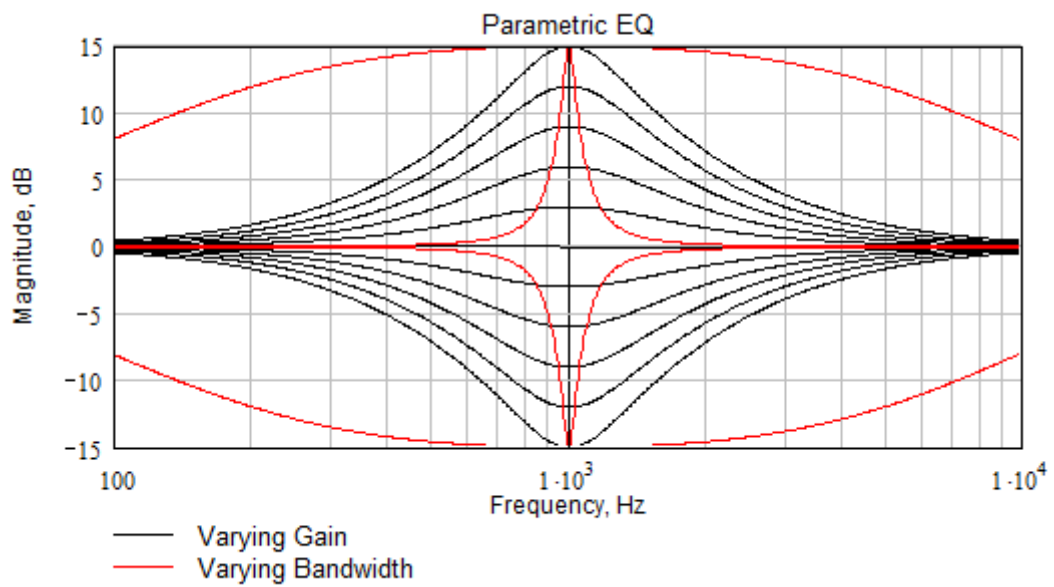
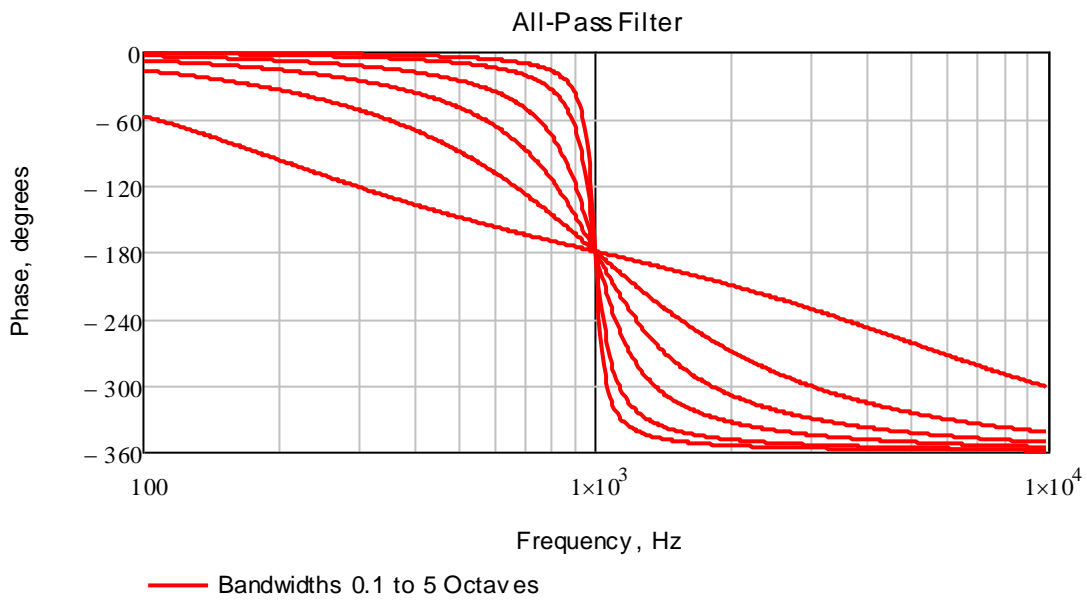

Technical Specifications

General

Number of Output channels	Four (44C) or Eight (88C)
Total power output (44C)	20,000/10,000/6,000 Watts RMS (44C20, 44C10, 44C06)
Total power output (88C)	20,000/10,000/6,000/3,000 Watts RMS (88C20, 88C10, 88C06, 88C03)
Input types	Analog, AES3 (Dante optional, compatible with AES67)
Control, monitoring & alarm	Ethernet, configurable function Volt-free relay and contact closure port
Energy saving modes	Standby and deep sleep, both with auto-sleep timers
System sleep and wakeup	Front panel switch, network command, contact closure and audio detection
Max ambient temperature (full power, no limiting)	40degC (105degF)

Audio

Amplifier topology	Proprietary 5th generation Linea Research Class D.
Amplifier modulation scheme	Low feedback, multiple loop, with feedforward error correction.
Dynamic range (analog input to speaker output)	>113dBA typ.
Dynamic range (AES3 or Dante input to output)	>114dBA typ.
Frequency response	<7Hz to >30kHz, 4 Ohms, -2.5dB. (Note 1)
Total harmonic distortion, THD	<0.05% typ, 1kHz, AES17, 4 Ohms.
Inter-channel crosstalk (worst combination of channels)	better than -85dBr at 1kHz. better than -75dBr at 10kHz.
Maximum analog input level	+20dBu.
Slew rate	>60V per microsecond typical
Damping factor (Ref 8 Ohms)	>800 at amplifier output (see Linea's "Damping factor debunked" whitepaper)
Analog input sensitivity range for full output	0dBu to +20dBu, continuously adjustable.
Analog input	20k Ohm, electronically balanced.
Analog link	Directly connected to the analog input.
Analog ground scheme	AES48 standard compliant.
AES3 input	Transformer isolated.
AES3 link	Actively regenerated with automatic direct bypass to the AES3 input if the unit is unpowered. Do not 'daisy-chain' more than 8 amplifiers from a single AES3 source.
AES3 supported sampling rates	24kHz to 192kHz (auto locking).

Note 1: On 8-output models, the frequency response reduces to 23kHz on outputs which have FIR enabled.

Digital processing

Resolution	40 bit, using proprietary LMD (Linea-Micro-Detail) algorithms.
Sample rate	96kHz throughout.

Special functionality:

Class leading limiter suite	See the 'speaker protection systems' section.
Hardman crossover filters	Better out of band rejection than Linkwitz-Riley (Unique to Linea).
LIR crossover filters	Linear Phase without the compromises of FIR filters (Unique to Linea).
FIR Shelving EQ filters	For linear phase filtering.
FIR Output filters	For equalisation or crossovers with linear/arbitrary phase (on some models).
Overlays	Twelve additional independent overlays of EQ, Delay and Gain.

Power Output

Model	44 series C20	44 series C10	44 series C06
Power specification	RMS output power per channel, all channels driven with continuous program material and a nominal ambient temperature of 40degC / 105degF		
Crest Factor of 4 (12dB), 2-Ohm nominal load	5,000W	2,500W	1,500W
Crest Factor of 2.8 (9dB), 4-Ohm nominal load	3,000W	2,500W	1,500W
Crest Factor of 2 (6dB), 8-Ohm nominal load	1,500W	1,500W	1,500W (when set correctly)
Bridged, per channel pair, 4 Ohm load	10,000W	5,000W	3,000W
25V line (CV) operation, Crest Factor 4 (12dB)	1250W	885W	685W
70V line (CV) operation, Crest Factor 4 (12dB)	3500W	2,500W	1,500W
100V line (CV) operation, Crest Factor 4 (12dB)	5,000W	2,500W	1,500W

Model	88 series C20	88 series C10	88 series C06	88 series C03
Power specification	RMS output power per channel, all channels driven with continuous program material and a nominal ambient temperature of 40degC / 105degF			
Crest Factor of 4 (12dB), 2-Ohm nominal load	1,500W	1,250W	750W	400W
Crest Factor of 2.8 (9dB), 4-Ohm nominal load	2,500W	1,250W	750W	400W
Crest Factor of 2 (6dB), 8-Ohm nominal load	1,500W	1,250W	750W	400W
Bridged, per channel pair, 4 Ohm load	3,000W	2,500W	1,500W	800W
25V line (CV) operation, Crest Factor 4 (12dB)	685W	625W	485W	355W
70V line (CV) operation, Crest Factor 4 (12dB)	1,935W	1,250W	750W	400W
100V line (CV) operation, Crest Factor 4 (12dB)	2,500W	1,250W	750W	400W

Power supply

Topology (main power supply)	3rd generation Series Resonant.
Topology (auxiliary and standby supplies)	Low quiescent Eco-Flyback.
Internally stored energy	>600 Joules.
Mains input voltage range (automatically configured)	85V to 240V.
Mains input frequency range	47Hz to 63Hz.
Mains inrush current (max for <10ms)	6A at 115V, 12A at 230V.

Protection systems

Note : Under all circumstances the control and protection systems will endeavor to deliver the maximum power possible for a given set of conditions, applying limiters only in extreme circumstances. Muting will only occur when a dangerous situation is detected, normal operation automatically resuming when the condition clears.

System protection

Excessive output current
Excessive power supply current

Excessive amplifier section temperature

Excessive power supply section temperature

Excessive DSP section temperature

Mains voltage out of range

Fan speeds out of range

Internal power rails out of range

Speaker protection

Audio soft-clip limiter

VxLim, Multiband peak limiter
(Unique to Linea)

VxMax, Multiband overshoot limiter
(Unique to Linea)

Vx-Tmax, Driver thermal limiter

(long term power limiter)

DC offset protection

Excessive HF energy (VHF) limiter

Power distribution protection systems

Mains inrush current limiting (soft start and anti-surge).

Mains average current limiting (mains breaker / fuse trip protection).

Randomised initialisation when powered up to reduce the peak power demand in large systems.

Monitoring and logging

Supply current logged vs time

Supply voltage logged vs time

Thermal Capacity logged vs time

Each driver current logged vs time

Each driver impedance logged vs time

Protection limiting for each output logged vs time

Number of power cycles counted

Number of mains brownout events counted

Fan speeds continuously monitored

Fan underspeed events counted

Various protection mute events counted

Driver Impedance continuously monitored

An inbuilt alarm and notification system can be configured to indicate problems to remote devices either via the network or the Volt-free changeover relay contacts accessibly on the rear panel.

OEM Features

Most parameters may be individually hidden (OEM locked) from the user with access being password protected.

Physical

Cooling

Airflow

Air filtration

Analog IN and LINK connectors

AES3 IN and LINK connectors

Audio output connector

Mains input connector

Dante Primary and Secondary

Relay output & contact closure inputs/output

LED indicators

Relay contacts

Depth (behind rack ears)

Net Weight

Variable speed fans.

Front to back.

Washable media, changeable without the use of tools.

Genuine Neutrik XLR.

Genuine Neutrik XLR.

Genuine Neutrik Speakon.

Genuine Neutrik 32A Powercon.

Shielded RJ45.

Phoenix pluggable terminal blocks.

Bright, easily differentiated.

Can switch between 10uA and 1A at up to 30V

357mm (14").

12.5kg (27.5 pounds).

Options

There is internal provision for digital audio network option cards to be factory fitted. Currently Linea Research support Dante/AES67 from Audinate.

Rear rack support kit (part number ZA1182).